



MZ Construction Consumable
Supply LTD
10 North Avenue, Hayes,
Middlesex, United Kingdom,
UB3 2JE
Contact Number:
+442080610941
+447424438725

Contact Email: mz@mzccs.co.uk
Web site: www.mzccs.co.uk



the biggest innovations start with a small idea

Catalog. 2024 

- 
- 
- 
- 
- 
- 
- 
- 
- 
- 
- 

High Quality Cameras for Hazardous Areas.



Contents

SAMCON - The Company	3
ExCam - Comparison Chart	6
Analog Cameras (Ex)	8
The ExCam miniTube - Ultracompact Day/Night Multisignal Camera.....	8
The ExCam e.Vario - Powerful Day/Night Motor Zoom Camera with IR Cut.....	9
TCP/IP Network Cameras (Ex)	10
The ExCam IPM3016 - PoE Network Camera with Fix Lens and FullHD Resolution.....	10
The ExCam miniTube IP - Compact IP-Camera with Motorized Varifocal Lens	11
The ExCam IPM1137-LE - PoE Network Camera 5MP with integrated Illumination.....	12
The ExCam IPM2036 - PoE Network Camera with Fix Lens and 4MP Resolution.....	13
The ExCam IPP1275 - Ultra Compact Varifocal-Camera	14
The ExCam IPP1377 - IP-Megapixel-Camera (5MP) with Remote Zoom & Focus	15
The ExCam IPQ1656 - Powerful PoE Camera with Remote Zoom & Focus and AI.....	16
The ExCam IPQ1715 - PoE Networkcamera with Motor Zoom, Auto Focus & DLPU.....	17
The ExCam IPQ1785 - PoE Networkcamera with Motor Zoom & Auto Focus in FullHD	18
The ExCam IPP3827 - 180° Panorama Network Camera with 7 MP Resolution	20
The ExCam IPP5655 MKII - PoE Network Dome Camera with 32x Motor Zoom & FullHD	21
The ExCam IPQ6075 - PoE Network Dome Camera with 40x Motor Zoom & FullHD	22
The ExCam IPP1280 - Ultra Compact Thermal Network Camera	23
The ExCam XI80 - Thermal Camera with Auto Focus and Infrared-Thermometer.....	24
The ExCam XI410 - Thermal Camera with Motor Focus and Infrared-Thermometer.....	25
Modular Ex Cameras - Sensor Units and Main Units.....	26
Robust Cameras for Safe Areas (non Ex)	29
The RoughCam Series - Extreme Robust Cameras for Safe Areas and Sterile Rooms.....	29
Ex-d Camera Enclosures	32
The T07-Series - Flameproof Camera Enclosure Series.....	32
Ex Lighting Systems	36
liteServer Ex.micro - Ultracompact Luminaire for Process Illumination.....	36
Lighting Systems for Safe Areas (non Ex)	39
The liteServer Rough.micro - Ultracompact Luminaire for Process Illumination.....	39
Mounting Accessories	40
Installation Equipment	43
Wash and Wipe Equipment	44
The smart.Cleaner - IP-Washing Water Supply Unit for up to 4 Cameras.....	44
The cam.Cleaner - Washing Fluid Supply Unit Single Port.....	46
The air.Blade - Pneumatic Cleaning System, better sight in dusty environments	47
The water.Blade - Hydraulic Cleaning System.....	48
Cable & Wiring	49
System Cables for Analog Cameras (CVBS).....	49
System Cables for TCP/IP Network Cameras.....	50
(Ex)Connection Rails - Connection and Transmission Units	52
The Connection Rail Series - Plug & Play Compact Cabinets for Safe Areas	52
The ExConnection Rail Series - Connection and Transmission Units for Ex- Zones	53
Accessories for (Ex)Connection Rail Series	54
Our Customers	55
Our Team	55
Our Certificates	56
Our Type Examinations	57
ExCam Series Model Key	59

SAMCON - The Company



SAMCON Prozessleittechnik GmbH was founded in 1992 and is located in Lohra-Altenvers, near Marburg and currently has 18 employees. The company is specialized in the development, production and sale of devices, software as well as engineering services in the area of camera and communication systems for hazardous areas. The general managers of the company are Steffen Seibert and Roger Thoms.

Since 2008, the company has met the requirements for quality management specified by the directive 2014/34/EU (ATEX) and produces camera and communication systems for hazardous areas. In 2014, SAMCON extended their quality management system, now also comprising ISO 9001:20015 as well as IECEx QAR. Since 2007, SAMCON has been an Axis development partner and in 2013 this partnership was extended as both companies now jointly cooperate as technology partners.

SAMCON cameras are certified by the TÜV, the German Technical Inspection Authority. Whether simple explosion proof camera-monitor systems are required or complex CCTV systems have to be implemented - SAMCON always strive to offer the best solution to our customers. SAMCON's most important objectives are high quality planning, well thought-out equipment technology, safety, and of course customer satisfaction.

Camera and Communications Systems for Hazardous Areas.

In the area of automation technology, a tendency is noticeable that CCTV systems (Closed Circuit Television) extend and even replace classical sensor technology. With the digitalization of video streams the possibilities increase to effectively integrate them into existing process control systems and procedures. The requirement spectrum of CCTV systems in hazardous areas ranges from rather simple observations by the means of static passive video sources, to cameras disposing of a zoom function and intelligent evaluation units, to complex PTZ cameras such as dome camera systems.

Due to the constantly increasing demands which explosion proof cameras have to fulfil as well as our effort to realize and implement our customers' requirements, our current scope comprises:

- Development, manufacturing and direct distribution of explosion proof camera systems and the applicable components
- Compilation of technical concepts to realize CCTV systems in hazardous areas
- Planning and project implementation of CCTV systems in hazardous areas
- Planning and development of analog and digital signal processing and analytical systems



Our Customers and their Industries

Our global customers, often internationally operating corporations, operate systems in potentially explosive areas. The danger of gas and dust explosions and the risk of explosions in mines and mines are among the areas of application of our camera and lighting systems.

Our systems are used, for example, in offshore plants, chemical and petrochemical industrial companies, smaller operators of biogas plants or pipeline operators who are responsible for transporting energy. Fast-growing industries include alternative energies, such as hydrogen plants or modern ships that run on LNG.

Our IP-based Ex camera systems offer worldwide access (for example via secure VPN tunnels). This means the cameras can be viewed and controlled from anywhere in the world. The ex-camera can also send its information, for example from a remote biogas plant, directly to the workplace. In combination with the Ex lighting systems, lighting conditions can also be optimized, as process lighting in apparatus and mechanical engineering, but also as outdoor lighting, e.g. on drilling platforms.



Explosionproof Cameras for Oil- and Gas Industry.

Oil and gas are important energy sources and are difficult to replace, especially for mobile applications. Cameras enable upstream, midstream and downstream oil and gas activities to be monitored and documented safely and effectively; Regardless of whether it is an oil well, pipeline, compressor station, refinery or tank farm, cameras increase security. Our ExCam series is extremely robust: The weatherproof stainless steel housing is IP68 dustproof and waterproof against temporary submersion.



Chemical Industry.

Chemical plants are extensive. Large areas can be overlooked. Many processes take place at the same time. Distances are great; Safety standards high. The level of automation in the chemical industry is high. Devices have to provide 100% power especially where people cannot work or can only work to a limited extent - be it because of high pressure, extreme temperatures or hostile atmospheres. Our devices are designed for corrosive, acidic or sulfurous atmospheres.



Pharma Industry.

Development and research of new active ingredients is important. Existing processes are constantly optimized and aligned with applicable regulations. Better and better medicines have to be manufactured more and more cost-effectively in order to survive global competition. Not only the quality and purity of the products play a major role, but also system safety. Our camera systems increase the level of automation in pharmaceutical production systems.



Safety and Reliability on the high Seas - Marine and Vessel.

The sea is definitely one of the most demanding environments on earth. Devices used here must withstand corrosive salt water, storms and extreme temperatures. This is why equipment that can withstand these harshest environmental conditions is required in the marine and shipping sectors, in the transport of liquefied natural gas ("Liquefied Natural Gas"; LNG for short), its use as a drive for ships, as well as in tough offshore use.



Cameras for Mechanical Engineering.

In mechanical engineering, cameras and optical sensors have long been an essential part of control systems. A general distinction is made between two use cases: video surveillance and industrial image processing. What both use cases have in common is that SAMCON cameras at least partially give machines the ability to see and make human decisions.



Solutions for the Power Plant- and Energy Industry.

In order for biogas plants to be optimally controlled and operated as efficiently as possible, plant operators need certain information: What is the condition of the biomass (substrate) in the fermenter? How high is the filling level? Do solids float on the surface? Does the substrate foam? Is the agitator still working properly? SAMCON cameras answer these questions.



Solutions for Critical Infrastructure / Transportation.

These sectors include, for example, water, energy, waste disposal and now also IT organizations or companies. Specific industry examples include petrochemical plants, offshore platforms and also mines. The importance is reflected in the comprehensive regulations and specifications. The sustainable efficiency of the systems in question is always a priority and must be guaranteed even in crises. SAMCON network devices can provide useful and easily accessible insights into critical infrastructure locations thanks to intelligent analytics capabilities.

ExCam® Series

High Quality Cameras
for Hazardous Areas
by SAMCON.EU



The **ExCam Series** consists of different video cameras that are approved for dust and gas explosion risk zones, as well as mining, in accordance with the EU Directive 2014/34/EU (ATEX), the IECEx Schema and EAC-Ex.

The ExCam Series is the **world's smallest explosion proof camera system in its class**. The main advantage lies in the modular design: various different housings and electronic parts make it easy to assemble explosion proof cameras that suit your particular needs. The **ExCam Series** consists of analogue cameras with varifocal lenses, motor-zoom cameras with infrared cut filter and digital network cameras with a resolution of more than 1920x1080 pixel (FullHD).



Explosion Protection

The ExCam Series has been designed for use in hazardous areas and it is certified according to European regulations (ATEX) as well as international ones (IECEx). Furthermore it is also certified according to EAC-Ex to meet the requirements of the custom union, to UKEX, INMETRO, MASC and PESO. The cameras certification comprises ATEX group I (mining) with a low risk of mechanical threat as well as ATEX group II for zone 1, 2 as well as 21 and 22 including the explosion groups IIC / IIIC with a high risk of mechanical threat. Further certification upon request. In accordance with the requirements of the impact and free-fall tests (DIN EN 60079: 0 2012), the housings are suitable for fix and portable applications!



Media Resistance and Sealings

Due to high-quality materials used for the ExCam series it meets the requirements of a comprehensive media resistance list! It is also possible to freely select different stainless steel alloys to reflect the best execution for the application. Even a coating or powder coating of the housing is feasible to realize individual media resistance requirements. The particularly designed GYLON (PTFE) flat sealing does not only ensure the housing to be watertight (IP68) but also supports the resistance towards several chemicals. In addition, the housings are also protected against strong jets of water (IP66). The extremely robust and scratch-proof as well as high-impact resistant borosilicate glass fits perfectly into the high-quality materials of the housing body.



Mining

As one of the first flameproof camera protection systems, the ExCam series meets all mining requirements (environments susceptible of fire damps) and is certified according to ATEX/IECEx for equipment group I M2 (Mb). If the housing series is used in mining environments with a low risk of mechanical damages it is even not necessary to equip the housing with an additional device in order to protect the borosilicate glass! As a result, the ExCam series allows for the first time a usage of stationary as well as portable surveillance systems underground.



Temperatures

Also with regard to the allowed ambient temperatures the ExCam Series sets new standards.









The temperature limits with integrated heater are -60°C. Equipped with an active cooling system we can reach +130°C.













Using active cooling, even high-end cameras can be used at high ambient temperatures!

ExCam - Comparison Chart

Cameras with an analog signal output







														
	Product	Model-Keys	Ex-Certification ¹⁾	Prot.-Level	Enclosure Material ²⁾	T _{min} / T _{max} ³⁾	Power Supply	Lens/IR-Filter	Min. -Illumination	Angle of View	Signal ⁴⁾	Video-comp. / Resolution ⁵⁾	More Info	
Analoge CVBS Signal		ExCam miniTube	T08-VA0.1...	ATEX, IECEx, EAC-Ex, UKEX, INMETRO, PESO & MASC: Dust & Gas	IP66/68	Stainless Steel	-10°C / +50°C	12 V DC / 1.2 W	FIX / YES	0.01 lx	80° (wide) / 41° (tele)	AHD / FBAS	1/2.9" CMOS	
		ExCam e.Vario	T08-VA1.2...	ATEX, IECEx, EAC-Ex, UKEX, INMETRO, PESO & MASC: Dust & Gas	IP66/68	Stainless Steel	-40°C / +50°C	14 V DC to 30 V DC / 2.6 W	VARI-FOCAL / YES	0.1 lx	65° (wide-) / 31.2° (tele)	CVBS / AHD / TVI / CVI	1/2.8" CMOS	

TCP/IP Network cameras



														
	Product	Model-Keys	Ex-Certification ¹⁾	Prot.-Level	Enclosure Material ²⁾	T _{min} / T _{max} ³⁾	Power Supply	Lens/IR-Filter	Min. -Illumination	Angle of View	Signal ⁴⁾	Video-comp. / Resolution ⁵⁾	More Info	
TCP/IP Net work cameras		ExCam IPM3016	T08-VA1.2...	ATEX, IECEx, EAC-Ex, UKEX, INMETRO, PESO & MASC: Dust & Gas	IP66/68	Stainless Steel	-60°C / +55°C	PoE, IEEE 802.3af Class 1 / Max. 3.8 W / Typ. 2.9W	FIX / NO	0.4 lx	90° (wide)	TCP/IP / RTSP / HTTP... / VAPIX® / ONVIF®	MJPEG / H.264/265 / 2304x1296	
		ExCam miniTube IP	T08-VA1.2...	ATEX, IECEx, EAC-Ex, UKEX, INMETRO, PESO & MASC: Dust, Gas & Mining	IP66/68	Stainless Steel	-30°C / +50°C	PoE, IEEE 802.3af Class 2 / Max. 4.4 W / Typ. 3.0 W	VARIO FOCUS (4x) / YES	0.0008 lx	80° (wide)	TCP/IP / RTSP / HTTP... / VAPIX® / ONVIF®	MJPEG / H.264/265 / 1920x1080 / 2.1 MP	
		ExCam IPM2036	T08-VA2.0...	ATEX, IECEx, EAC-Ex, UKEX, INMETRO, PESO & MASC: Dust & Gas, Mining	IP66/68	Stainless Steel	-60°C / +60°C (+120°C with accessory)	PoE, IEEE 802.3af Class 3 / Max. 12.95 W / Typ. 5.0 W	FIX / YES	0.04 lx	85° (wide) / 41° (tele)	TCP/IP / RTSP / HTTP... / VAPIX® / ONVIF®	MJPEG / H.264/265 / 2668x1512	
		ExCam IPP1275	T08-VA0.1...	ATEX, IECEx, EAC-Ex, UKEX, INMETRO, PESO & MASC: Dust & Gas,	IP66/68	Stainless Steel	-20°C / +50°C	PoE, IEEE 802.3af Class 2 / Max. 4.1 W / Typ. 3.4 W	VARIO FOCUS / NO	Color: 0.22 lx	82° (wide) / 53° (tele)	TCP/IP / RTSP / HTTP... / VAPIX® / ONVIF®	MJPEG / H.264 / 1920x1080	
		ExCam IPP1377	T08-VA2.3...	ATEX, IECEx, EAC-Ex, UKEX, INMETRO, PESO & MASC: Dust & Gas, Mining	IP66/68	Stainless Steel	-60°C / +60°C	PoE, IEEE 802.3af Class 3 / Max. 10.7 W / Typ. 5.4 W	REMOTE ZOOM & FOCUS / YES	Color: 0.13 lx, F1.2 B/W; 0.03 lx, F1.2	103°(wide) / 38° (tele)	TCP/IP / RTSP / HTTP... / VAPIX® / ONVIF®	MJPEG / H.264/265 / 2592x1944 / 5 MP	
		ExCam IPQ1656	T08-VA2.3...	ATEX, IECEx, EAC-Ex, UKEX, INMETRO, PESO & MASC: Dust, Gas & Mining	IP66/68	Stainless Steel	-60°C / +60°C (+130°C with accessory)	PoE, IEEE 802.3af Klasse 3 / Max. 8.2W / Typ. 5.1 W	REMOTE ZOOM, & FOCUS / YES	Color: 0.05 lx, B/W; 0.01 lx	100° (wide) - 47° (tele)	TCP/IP / RTSP / HTTP... / VAPIX® / ONVIF®	MJPEG / H.264/265 / 2688x1512 / 4 MP	
		ExCam IPQ1785	T08-VA2.3...	ATEX, IECEx, EAC-Ex, UKEX, INMETRO, PESO & MASC: Dust & Gas, Mining	IP66/68	Stainless Steel	-60°C / +60°C	PoE, IEEE 802.3af Class 3 / Max. 12.9 W / Typ. 7.7 W	MOTOR ZOOM (32x) & AUTO FOCUS / YES	Color: 0.16 lx, F1.2 B/W; 0.03 lx, F1.2	60° (wide) - 2.3° (tele)	TCP/IP / RTSP / HTTP... / VAPIX® / ONVIF®	MJPEG / H.264 / 1920x1200	
		ExCam IPQ1715	T08-VA2.2...	ATEX, IECEx, EAC-Ex, UKEX, INMETRO, PESO & MASC: Dust & Gas, Mining	IP66/68	Stainless Steel	-60°C / +50°C (+120°C with accessory)	PoE, IEEE 802.3af Klasse 4 / Max. 13.5 W / Typ. 12.0	MOTOR ZOOM (21x), AUTO FOCUS / YES	Color: 0.1 lx B/W; 0.02	76° (wide) / 3.6° (tele)	TCP/IP / RTSP / HTTP... / VAPIX® / ONVIF	MJPEG / H.264, H.265 / 1920x1080	
		ExCam IPP3827	T08-VA4.1K. PS1...	ATEX, IECEx, INMETRO, EAC-Ex, UKEX, PESO & MASC: Dust & Gas	IP66/68	Stainless Steel	-50°C / +60°C	PoE, IEEE 802.3af Klasse 4 (PoE+) / Max. 18 W	4x1/2.8" RGB CMOS	Color: 0.15 lx B/W; 0.05 lx	180° Panoramic / 90° vertikal	TCP/IP / RTSP / HTTP... / VAPIX® / ONVIF®	MJPEG / H.264/265 / 3712x1856 / 7MP	
		ExCam IPP5655 MKII	T08-VA4.1K. PS1...	ATEX, IECEx, INMETRO, EAC-Ex, UKEX, PESO & MASC: Dust & Gas	IP66/68	Stainless Steel	-30°C / +60°C	PoE, IEEE 802.3af (PoE+) / Max. 19 W	32xMotor Zoom, PTZ / YES	Color: 0.1 lx B/W; 0.02 lx	58.3° (wide) / 2.4° (tele)	TCP/IP / RTSP / HTTP... / VAPIX® / ONVIF®	MJPEG / H.264 / 1920x1080 @25fps / 2.1 MP	
		ExCam IPQ6075	T08-TNXCD...	ATEX, IECEx & EAC-Ex: Dust & Gas	IP66/68	Stainless Steel	-50°C / +60°C	PoE, IEEE 802.3af (PoE+) / Max. 17.1W	40xMotor Zoom, PTZ / YES	Color: 0.1 lx B/W; 0.002 lx	65° (wide) / 2° (tele)	TCP/IP / RTSP / HTTP... / VAPIX® / ONVIF®	MJPEG / H.264 / 1920x1080	

Thermal-Cameras



Thermal		ExCam IPP1280	ExCam XI80	ExCam XI410
	Product			
	Model-Keys	T08-VA0.1...	T08-VA0.4...	T08-VA0.4...
	Ex-Certification ^{*1}	ATEX, IECEx & EAC-Ex, ...: Dust, Gas	ATEX, IECEx & EAC-Ex, ...: Dust, Gas	ATEX, IECEx & EAC-Ex, ...: Dust, Gas
	Protection Level	IP66/68	IP66/68	IP66/68
	Enclosure Material ^{*2} Weight	Stainless Steel 0.7g	Stainless Steel 0.9g	Stainless Steel 0.9g
	Ambient Temperature T_{min} T_{max}	-30°C +60°C	-10°C +50°C	-10°C +50°C
	Temperature Measured Objects T_{mess}	-66°C +89°C	-20°C...900°C switchable	-20°C...900°C switchable
	IR-Thermometer	NO	YES	YES
	Spot-Finder	NO	YES	YES
	Elektr. Connection	FA54, Main Unit	Ethernet, 10-30VDC	Ethernet, 10-30VDC
	System Cable/ max. Length	SKD04-T.flex/ 25m	SKDP03-T / 100m	SKDP03-T / 100m
	Angle of View	35.4°	55° standard / 12° tele / 30° normal / 80° wide	53° standard / 18° tele / 29° normal / 80° wide
	MOD (min. Object Distance)	1m	0.2m	0.2m
	Motor Focus	NO	YES	YES
	Optical Resolution	208x156	80x80	384x240
	Frame Rate	8.3 Hz	50 Hz	25 Hz
	Sensitivity (NETD)	<100mK	<100mK	<80mK
	Technology / Image Sensor	Uncooled Microbolometer (UFPA)	Uncooled Microbolometer (UFPA)	Uncooled Microbolometer (UFPA)
	Spectral Range	8-14 μ m	8-14 μ m	8-14 μ m
	Visualization and Operation	Webinterface via FA54 Main Unit	Optris PixConnect Software	Optris PixConnect Software
	Multi User	YES	NO	NO
	Process Interface (AO/DI/DO)	NO	YES (4-20mA)	YES (4-20mA)
	More Information			

Device-Combination Camera with Light

	Product	Model Key	Ex-Certification ^{*1}	Prot.-Level	Enclosure Material ^{*2}	T_{min} T_{max} ^{*3}	Power Supply	Lens/IR-Filter	Min. -Illumination	Angle of View	Signal ^{*4}	Video-comp. / Resolution ^{*5}	More Info
Combi	 ExCam IPM1137- LE	T08-VA2.2... T20-VA0.1	ATEX, IECEx Dust & Gas	IP66/68	Stainless Steel	-30°C +50°C	Camera: PoE, IEEE 802.3af Class 4 Max.25.5W Typ. 19.5 W Light: 12.9W@24VDC	REMOTE ZOOM,& REMOTE FOCUS/ YES	Color: 0.17 lx B/W: 0.03 lx	103° (wide) 54° (tele)	TCPIP RTSP HTTP... VAPIX® ONVIF®	MJPEG H.264/265 2592x1944 5 MP	

***1: Ex Certification (see Model Key):**

ATEX Marking & Certification:

Gas: II 2G Ex db IIC T6 Gb

Dust: II 2D Ex tb IIIC T80°C Db

Mining: I M2 Ex db I T6 Mb

IECEx & EAC-Ex Marking & Certification:

Gas: Ex db IIC T6 Gb

Dust: Ex tb IIIC T80°C Db

Mining: Ex db I T6 Mb

***2: Housing Materials:**

Stainless Steel
1.4301 / 1.4401 / 1.4404
(AISI 304 / 316 / 316L)

***3: Ambient Temperature:**

Please see Model key.

***4: Video Signal:**

PAL CVBS/FBAS/AHD/TVI/CVI as standard
NTSC Models on demand

The ExCam miniTube - Ultracompact Day/Night Multisignal Camera



ExCam miniTube
in a stainless steel housing

ExCam miniTube

The **ExCam miniTube To8** is a fix multisignal camera certified according to **Directive 2014/34/EU (ATEX), IECEx and EAC-Ex**. Thanks to its 1/2.9" CMOS sensor it offers excellent image quality and an improved **light sensitivity and colour rendering**. As a result the **ExCam miniTube** delivers high resolution pictures even at an illumination level of only 0.01 lx. Despite its ultracompact dimensions, it has a high resolution of 1080p (1920x1080) 25p/30p.

Group II (Gas & Dust)	ATEX / IECEx / EAC-Ex					Group I (Mining)	ATEX / IECEx..	
Zone	0	1	2	21	22	Category	Ma	Mb
Application	✗	✓	✓	✓	✓	Application	✗	✗

Product / Model	Description	
 <p>ExCam miniTube T08-VA0.1.K1.BOR-N.N-005.N-P-0XX</p>		<p>Multisignal Camera in a stainless steel housing in accordance with Directive 2014/34/EU (ATEX), IECEx, EAC-Ex and more. Lens: 1/2.9" CMOS Minimal illumination: 0.01 lx F1.2 Angle of view: 80° (HD, 16/9, standard), optional 56° or 41° Resolution: 1920x1080 (FullHD) Explosion protection (gas): Ex II 2G Ex db IIC T6 Gb Explosion protection (dust): Ex II 2D Ex tb IIIC T80°C Db IP68 Protection Level: IP 66/68 (IEC / EN 60529) Ambient temperature limit: -10°C < T_{amb} < +50°C www.samcon.eu/en/products/analog/excam-minitube/ www.samcon.eu, product group: A, tariff number: 8525 8900</p>
<p>ExCam miniTube T08-VA0.1.K1.BOR-N.N-005.N-K-0XX</p>		Camera with terminal block termination
 <p>Video converter</p>		<p>Video converter converts the AHD video signal into a 4CIF signal for the connection of non-HD capable video server Video input: AHD, TVI, CVI, FBAS Video output: HDMI, VGA, FBAS (PAL, NTSC) Power supply: 12 V DC; Operating temperature: 0°C to 55°C OSD Menu: Brightness, Contrast, color, resolution, PIP, 4:3/16:9, etc. Product group: C</p>
 <p>Axis P7304</p>		<p>4-Channel Ethernet video server Videocompr.: MJPEG and H.264, H.265; transmission rate: 30 fps Resolution: 1920x1080 (max.); Digital In/Outputs: 4 configurable Interfaces: 2xRS422/485; Internal recording storage: via SD Slot Required IP addresses: 1 for 4 channels Power supply: 8-28 V DC or PoE class 1 Product group: C</p>
<p>A wide range of mounting accessories...</p>	can be found on #page 40!

The ExCam e.Vario - Powerful Day/Night Motor Zoom Camera with IR Cut







ExCam e.Vario
in a stainless steel housing

ExCam e.Vario

The **ExCam e.Vario To8** is a motorized zoom camera certified according to **Directive 2014/34/EU (ATEX), IECEx, and EAC-Ex**. With its 1/2.8" CMOS sensor and the IR cut filter it is one of the **most light sensitive cameras of its class**. It delivers excellent image quality, high light sensitivity and high resolution pictures. Although small in size it delivers a motorized varifocal lens, allowing it to be optimally adapted to a specific angle and lighting situation by remote control.

Group II (Gas & Dust)	ATEX / IECEx / EAC-Ex					Group I (Mining)	ATEX / IECEx..	
Zone	0	1	2	21	22	Category	Ma	Mb
Application	✗	✓	✓	✓	✓	Application	✗	✗

Product / Model	Description	
ExCam e.Vario T08-VA1.2.K1.BOR-L.N-005.N-X 		Varifocal camera in a stainless steel housing in accordance with Directive 2014/34/EU (ATEX), IECEx, EAC-Ex (CR TU) and more Equipped with motorized varifocal lens Minimal illumination: 0.5 lx (color), 0.1 lx (b/w) Angle of view: 65° (wide) to 31° (tele) Day/night function within IR cut filter Power supply: 14VDC to 30VDC Max. power: 2.64W Explosion protection (gas): Ex II 2G Ex db IIC T6 Gb Explosion protection (dust): Ex II 2D Ex tb IIIC T80°C Db Protection Level: IP 66/68 (IEC / EN 60529) Ambient temperature limit: $-40^{\circ}\text{C} < T_{\text{amb}} < +50^{\circ}\text{C}$ www.samcon.eu/en/products/analog/excam-evario www.samcon.eu, product group: A, tariff number: 8525 8900
ExCam e.Vario remote control 		Remote control for ExCam e.Vario to control focus and zoom without opening the housing! Signal: RS-485 Power supply: 12 V DC or 3V battery www.samcon.eu, Product group: C
Video converter 		Video converter converts the AHD video signal into a 4CIF signal for the connection of non-HD capable video server Video input: AHD, TVI, CVI, FBAS Video output: HDMI, VGA, FBAS (PAL, NTSC) Power supply: 12 V DC; Operating temperature: 0°C to 55°C OSD Menue: Brightness, Contrast, color, resolution, PIP, 4:3/16:9, etc. Product group: C
Axis P7304 		4-Channel Ethernet video server Videocompr.: MJPEG and H.264, H.265; transmission rate: 30 fps Resolution: 1920x1080 (max.); Digital In/Outputs: 4 configurable Interfaces: 2xRS422/485; Required IP addresses: 1 for 4 channels Power supply: 8-28 V DC or PoE class 1 Product group: C
A wide range of mounting accessories...	can be found on #page 40!

The ExCam IPM3016 - PoE Network Camera with Fix Lens and FullHD Resolution

















ExCam IPM3016
in the stainless steel enclosure

ExCam IPM3016

The **ExCam IPM3016** is a powerful IP-megapixel camera for the application in hazardous areas. It offers ultra compact size and Full HDTV resolution (1920p) in combination with a 90° lens. With **ATEX**, **IECEX**, and **EAC-Ex** approval for gas and dust areas, the camera has a variety of certifications.

Group II (Gas & Dust)	ATEX / IECEx / EAC-Ex					Group I (Mining)	ATEX / IECEx...	
Zone	0	1	2	21	22	Category	Ma	Mb
Application	✗	✓	✓	✓	✓	Application	✗	✓

Product / Model	Description	
ExCam IPM3016 T08-VA1.2.K1.BOR-N.N-005.N-P-090 	          	Network camera in a stainless steel housing in accordance with Directive 2014/34/EU (ATEX), IECEx, EAC-Ex (CR TU) and more. PoE, IEEE 802.3af/ 802.3at, type1 class 1 (max. 3.8 W, typ. 2.9 W) Minimal illumination: 0.35 lx at 50 IRE F2.4 Horizontal angle: 90° (wide) fix @16/9 Video compression: H.264 (MPEG-4 Part 10/AVC) Main and High Profiles, H.265 (MPEG-H Part 2/HEVC) Main Profile Motion JPEG Resolution: 2016 x 1512 to 320 x 240 (4:3) or 2304 x 1296 to 640x360 (16:9) Ex.-protection (gas): Ex II 2G Ex db IIC T6 Gb Ex.-protection (dust): Ex II 2D Ex tb IIIC T80°C Db Protection level: IP 66/68 (IEC / EN 60529) Ambient temperature range: $-20^{\circ}\text{C} < T_{\text{amb}} < +55^{\circ}\text{C}$ www.samcon.eu/en/products/network/excam-ipm3016/ Included accessories: 5 meter cable connected to RJ45 plug Product group: A, tariff number: 8525 8900
ExCam IPM3016 T08-VA1.2.K1.BOR-N.N-005.N-I-090		Camera with terminal box termination: Included accessories: 5 m cable with pre-mounted and pre-wired ex-e terminal box (see Ex-TB2) Product group: A, tariff number: 8525 8900
ExCam IPM3016 T08-VA1.2.K1.BOR-LL.N-005.N-P-090		Camera with housing heating for arctic temperatures Equipped with a self-regulating heater. Ambient temperature: $-60^{\circ}\text{C} < T_{\text{amb}} < +55^{\circ}\text{C}$ Included accessories: 5 meter cable connected to RJ45 plug Product group: A, tariff number: 8525 8900
ExCam IPM3016 T08-VA1.2.K1.BOR-LL.N-005.N-T-090		Camera with housing heating for arctic temperatures and terminal box termination: Equipped with a self-regulating heater. Ambient temperature: $-60^{\circ}\text{C} < T_{\text{amb}} < +55^{\circ}\text{C}$ Included accessories: 5 m cable with pre-mounted and pre-wired ex-e terminal box (see Ex-TB2) Product group: A, tariff number: 8525 8900
Option Mining		Explosion protection (mining): Ex I M2 Ex d I Mb Included accessories: 5 meter armoured cable connected to RJ45 plug
A wide range of mounting accessories...	can be found on #page 40!

new!

The ExCam miniTube IP - Compact IP-Camera with Motorized Varifocal Lens















ExCam miniTube IP
in the stainless steel enclosure

ExCam miniTube IP

The **ExCam miniTube IP** is a compact, powerful network camera with motorized varifocal lens. It is particularly suitable for use in hazardous areas. The camera offers **Full HDTV-resolution** (1920p) and a 1/2.8" sensor for excellent image quality and outstanding light sensitivity. With **ATEX, IECEx, UKEX, INMETRO, EAC-Ex and more certifications** for gas- and dust explosive areas the camera has a broad certification landscape.

Group II (Gas & Dust)	ATEX / IECEx / EAC-Ex					Group I (Mining)	ATEX / IECEx...	
Zone	0	1	2	21	22	Category	Ma	Mb
Application	✗	✓	✓	✓	✓	Application	✗	✓

Product / Model	Description	
ExCam miniTube IP T08-VA1.2.K1.BOR-N.N-005.N-P 	          	Network camera in a stainless steel housing in accordance with Directive 2014/34/EU (ATEX), IECEx, EAC-Ex (CR TU) and more. PoE, IEEE 802.3af Type1 Class 2 (max. 4.4 W, typ. 3.0 W) Minimal illumination: 0.0008 lx at 40 IRE F1.6 Horizontal angle: 80° - 32° Video compression: H.264, H.264+, H.265, H265+, Motion JPEG Resolution: 1920 x 1080 (FullHD) Remote Zoom: 4x Explosion protection (gas): Ex II 2G Ex db IIC T6 Gb Explosion protection (dust): Ex II 2D Ex tb IIIC T80°C Db Protection level: IP 66/68 (IEC / EN 60529) Ambient temperature range: -30°C < T _{amb} < +50°C www.samcon.eu/en/products/network/excam-miniTube-ip Included accessories: 5 meter cable connected to RJ45 plug Product group: A, tariff number: 8525 8900
ExCam miniTube IP T08-VA1.2.K1.BOR-N.N-005.N-I		Camera with terminal box termination: Included accessories: 5 m cable with pre-mounted and pre-wired ex-e terminal box (see Ex-TB2) Product group: A, tariff number: 8525 8900
Option Mining		Explosion protection (mining): Ex I M2 Ex d I Mb Included accessories: 5 meter armoured cable connected to RJ45 plug
A wide range of mounting accessories...	can be found on #page_40!

new! The ExCam IPM1137-LE - PoE Network Camera 5MP with integrated Illumination





ExCam IPM1137-LE
in the stainless steel enclosure

ExCam IPM1137-LE

The combination solution: In order to optimize the performance of **ExCam IPM1137-LE** in difficult lighting conditions **lighting and camera are optimally coordinated** and **the light can be easily switched via the camera**. The camera: 5MP resolution meets remote-zoom-vario-focus-lens and MLPU (Machine Learning Processing Unit). The **liteServer Ex.micro**: the world's smallest LED spotlight for hazardous areas.

Group II (Gas & Dust)	ATEX / IECEx / EAC-Ex					Group I (Mining)	ATEX / IECEx...	
Zone	0	1	2	21	22	Category	Ma	Mb
Application	✗	✓	✓	✓	✓	Application	✗	✓

Product / Model	Description	
ExCam IPM1137-LE-WL T08-VA2.2.K1.BOR-L.H-005.N-P 		Network camera in a stainless steel housing in accordance with Directive 2014/34/EU (ATEX), IECEx, and EAC-Ex (CR TU) Equipped with external LED spotlight (white light) in Ex-d housing, switchable via web interface Camera ExCam IPM1137: PoE, IEEE 802.3af/802.3at Type2 Class4 (max. 25.5W, typ. 19.5W) Minimal illumination: color: 0.17 lx at 50 IRE F1.4; b/w: 0.03 lx Horizontal angle of view: 103° - 31° Video compression: H.264, H.265, Motion JPEG Resolution: 2592 x 1944 (5MP); Remote zoom and focus with i-CS Ex.-protection (gas): Ex II 2G Ex db IIC T6 Gb Ex.-protection (dust): Ex II 2D Ex tb IIIC T80°C Db Protection level: IP 66/68 (IEC / EN 60529) Ambient temperature range: -30°C < T _{amb} < +60°C LED-lighting liteServer Ex.micro 24.WL.90: High Power 12.5W COB LED; 12.9W@24VDC Luminous flux: max. 1930lm; beam angle: 90° Color temperature: 5000K (white light) Ex.-protection (gas): Ex II 2G Ex db IIC T5 Gb Ex.-protection (dust): Ex II 2D Ex tb IIIC T95°C Db Protection level: IP 66/68 (IEC / EN 60529) Ambient temperature range: -30°C < T _{amb} < +50°C www.samcon.eu/en/products/network/excam-ipm1137-le Included accessories: 5 meter cable connected to RJ45 plug Product group: A, tariff numbers: 8525 8900/ 9405 4910
ExCam IPM1137-LE-WL T08-VA2.2.K1.BOR-L.H-005.N-I		Camera-light-combination (white light) with terminal box termination: Included accessories: 5 m cable with pre-mounted and pre-wired ex-e terminal box (see Ex-TB3) Product group: A, tariff numbers: 8525 8900/ 9405 4910
ExCam IPM1137-LE-IR T08-VA2.2.K1.BOR-L.H-005.N-P		Camera-lighting-combination (infrared light) IR-LED-lighting liteServer Ex.micro 24.IR.90: High Power 12W SMD IR-LED; 12.7W@24VDC Luminous flux: max. 4210mW; beam angle: 90° IR centroid wavelength: 850nm Ex.-protection (gas):: Ex II 2G Ex db IIC T5 Gb Ex.-protection (dust): Ex II 2D Ex tb IIIC T95°C Db Protection level: IP 66/68 (IEC / EN 60529) Ambient temperature range: -30°C < T _{amb} < +50°C Included accessories: 5 meter cable connected to RJ45 plug Product group: A, tariff numbers: 8525 8900/ 9405 4910
ExCam IPM1137-LE-IR T08-VA2.2.K1.BOR-L.H-005.N-I		Camera-lighting-combination (IR light) with terminal box termination: Included accessories: 5 m cable with pre-mounted and pre-wired ex-e terminal box (see Ex-TB3) Product group: A, tariff number:s 8525 8900/ 9405 4910
A wide range of mounting accessories...		...can be found on #page 40!

The ExCam IPM2036 - PoE Network Camera with Fix Lens and 4MP Resolution







ExCam IPM2036
in stainless steel housing

ExCam IPM2036

The **ExCam IPM2036** is a powerful Day-/Night-IP-Megapixel-camera for hazardous areas. It offers **QuadHD/4MP resolution** (2668x1512), 3 lenses (85°, 56°, 41°) to choose, integrated IR illumination as well as a Deep Learning Processing Unit (DLPU) for intelligent analytics. With **ATEX, IECEx and EAC-Ex certification** for gas- and dust explosion risk areas the camera has a wide landscape of certification.

Group II (Gas & Dust)	ATEX / IECEx / EAC-Ex				
Zone	0	1	2	21	22
Application	✗	✓	✓	✓	✓

Group I (Mining)	ATEX / IECEx...	
Category	Ma	Mb
Application	✗	✓

Product / Model	Description
ExCam IPM2036 T08-VA2.0.K1.BOR-LL.H-005.N-P-085 	 <p>Network camera in a stainless steel housing in accordance with Directive 2014/34/EU (ATEX), IECEx, EAC-Ex (CR TU) and more. PoE, IEEE 802.3af/ 802.3at Type1 Class 3 (max. 12.95 W, typ. 5.0 W) Minimal illumination: color: 0.18 lx at 50 IRE F2.1; b/w: 0.04 lx 0 lx with IR illumination on (max. range of reach 2m) Horizontal angle of view: 85° (wide) fix@16/9, [alternative lenses 56° (normal), 41° (tele)] Video compression: H.264 (MPEG-4 Part 10/AVC) Main and High Profiles, H.265 (MPEG-H Part 2/HEVC) Main Profile Motion JPEG Resolution: 2304 x 1728 to 320 x 240 (4:3) or 2668 x 1512 to 640 x 360 (16:9) Ex.-protection (gas): Ex II 2G Ex db IIC T5 Gb Ex.-protection (dust): Ex II 2D Ex tb IIIC T95°C Db Protection level: IP 66/68 (IEC / EN 60529) Ambient temperature range: -60°C < T_{amb} < +60°C Included accessories: 5 meter cable connected to RJ45 plug www.samcon.eu/en/products/network/excam-ipm2036 Product group: A, tariff number: 8525 8900</p>
ExCam IPM2036 T08-VA2.0.K1.BOR-LL.H-005.N-T-085	Camera with terminal box termination: Included accessories: 5 m cable with pre-mounted and pre-wired ex-e terminal box (see Ex-TB2) Product group: A, tariff number: 8525 8900
ExCam IPM2036 T08-VA2.0.K1.BOR-LL.HH-010.N-T 	 <p>Camera with cool.Jacket „laminar Flow“ (VA2.o Series) Active cooling system for hot ambient temperatures: The cooling element is flooded with cooling water. So the inside temperature is kept below the maximum permitted value of the camera module by the principle of heat exchange. Explosion protection (gas): Ex II 2G Ex db IIC T3 Gb Explosion protection (dust): Ex II 2D Ex tb IIIC T195°C Db Ambient temperature: -50°C < T_{amb} < +120°C Product group: A, tariff number: 8525 8900</p>
Cooling unit	Mobile cooling unit with integrated flow controller
Valves and Tubes	Solenoid valves and tube packages upon request
ExCam IPM2036 T08-VA2.1.K1.BOR-X.H-005.N-X-056	Camera with alternative lens: Horizontal angle of view 56° (normal)
ExCam IPM2036 T08-VA2.1.K1.BOR-X.H-005.N-X-041	Camera with alternative lens: Horizontal angle of view 41° (tele)
Option Mining	 Explosion protection (mining): Ex I M2 Ex db I Mb Included accessories: 5 meter armoured cable connected to RJ45 plug
A wide range of mounting accessories...	...can be found on #page_40!

The ExCam IPP1275 - Ultra Compact Varifocal-Camera





ExCam IPP1275
in stainless steel housing

ExCam IPP1275

The **ExCam IPP1275** is a network camera, approved according to Directive 2014/34/EU (ATEX), IECEx & EAC-Ex. It is an **ultra compact** camera for use in hazardous areas – not only offering superb HDTV resolution (1920 x 1080) but also a powerful varifocal lens. The ExCam IPP1275 is a **modular** Ex-Network-Camera. This means that it consists of two units: the ultra compact **sensor unit** (lens and image sensor) and the **main unit** (network, power and memory card slot). It is ultra compact and cost effective.

Group II (Gas & Dust)	ATEX / IECEx / EAC-Ex				
Zone	0	1	2	21	22
Application	✗	✓	✓	✓	✓

Group I (Mining)	ATEX / IECEx...	
Category	Ma	Mb
Application	✗	✗

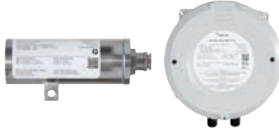
Product / Model	Description	
ExCam IPP1275 T08-VA0.1.K1.BOR-N.N-005.N-P 		Modular network camera: Sensor Unit in stainless steel housing in accordance with Directive 2014/34/EU (ATEX), IECEx and EAC-Ex (CR TU). Main Unit P12 MkII for safe areas Power Supply: PoE, IEEE 802.3af/802.3at Type1 Class 2 (typ. 3.4 W, max. 4.1 W) Minimal illumination: 0.22 lx, F2.0 Horizontal angle of view: 82° - 53° Resolution: 1920 x 1080 Functions: Fixed lens, Variofocus, 2.8 mm to 6 mm Explosion protection (gas): Ex II 2G Ex db IIC T6 Gb Explosion protection (dust): Ex II 2D Ex tb IIIC T80°C Db Protection Level (Sensor Unit): IP 66/68 (IEC / EN 60529) Protection Level (Main Unit): IP 66 (IEC / EN 60529) Ambient temperature: -20°C < T _{amb} < +50°C www.samcon.eu/en/products/network/excam-ipp1275/ Product group: A, tariff number: 8525 8900
ExCam IPP1275 T08-VA0.1.K1.BOR-N.N-005.N-TD 		Modular network camera: Sensor Unit in stainless steel housing, Main Unit P12 MkII in Ex-d housing in accordance with Directive 2014/34/EU (ATEX) and IECEx. Power Supply: PoE, IEEE 802.3af/802.3at Type1 Class 2 (typ. 3.4 W, max. 4.1 W) Explosion protection Sensor Unit (gas): Ex II 2G Ex db IIC T6 Gb Explosion protection Sensor Unit (dust): Ex II 2D Ex tb IIIC T80°C Db Explosion protection Main Unit (gas): Ex II 2G Ex d IIC T6 Gb Explosion protection Main Unit (dust): Ex II 2D Ex tb IIIC T80°C Db Protection Level (Sensor Unit): IP 66/68 (IEC / EN 60529) Protection Level (Main Unit): IP 66 (IEC / EN 60529) Ambient temperature: -20°C < T _{amb} < +50°C Product group: A, tariff number: 8525 8900
A wide range of mounting accessories...	can be found on #page 40!

The ExCam IPP1377 - IP-Megapixel-Camera (5MP) with Remote Zoom & Focus

















ExCam IPP1377
in stainless steel housing

ExCam IPP1377

The **ExCam IPP1377** is a network camera, approved according to 2014/34/EU (ATEX), IECEx und EAC-Ex. Its excellent image quality with up to 30 frames per second at **5MP resolution** makes it so special. In addition to the image detail it also offers a powerful **Remote-Zoom** and **Remote-Fokus lens (with i-CS)**: Viewing angles can be adjusted electronically without opening the housing.

Group II (Gas & Dust)	ATEX / IECEx / EAC-Ex				
Zone	0	1	2	21	22
Application	✗	✓	✓	✓	✓

Group I (Mining)	ATEX / IECEx	
Category	Ma	Mb
Application	✗	✓

Product / Model	Description	
ExCam IPP1377 T08-VA2.3.K3.BOR2-N.H-005.N-P 	           	Network camera in a stainless steel housing in accordance with Directive 2014/34/EU (ATEX), IECEx, EAC-Ex (CR TU) and more. Power supply camera: PoE, IEEE 802.3af / 802.3at Typ 1 Class 3, max. 10.7 W (typical: 5.4 W) Minimal illumination: Color: 0.13 lx, Black/White: 0.03 lx, F1.2 Horizontal angle of view: 103° - 38° (HD, 16/9) Resolution: 2592 x 1944 (5 Megapixel) to 160 x 90 Videocompression: H.264, H.265, Motion JPEG Explosion protection (gas): Ex II 2G Ex db IIC T6 Gb Explosion protection (dust): Ex II 2D Ex tb III C T80°C Db Protection level: IP 66/68 (IEC / EN 60529) Ambient temperature: -10°C < T _{amb} < +60°C www.samcon.eu/en/products/network/excam-ipp1377 Product Group: A, tariff number: 8525 8900
ExCam IPP1377 T08-VA2.3.K3.BOR2-N.H-005.N-T		Camera with terminal box termination: Included accessories: 5 m cable with pre-mounted and pre-wired ex-e terminal box (see Ex-TB3) Product Group: A, tariff number: 8525 8900
ExCam IPP1377 T08-VA2.3.K3.BOR2-LL.H-005.N-P		Camera with housing heating for arctic temperatures: Equipped with a self-regulating heater to meet extremely low temperature ranges. Explosion protection (gas): Ex II 2G Ex d IIC T5 Gb Explosion protection (dust): Ex II 2D Ex tb III C T95°C Db Protection level: IP 66/68 (IEC / EN 60529) Ambient temperature: -60°C < T _{amb} < +60°C Product Group: A, tariff number: 8525 8900
ExCam IPP1377 T08-VA2.3.K3.BOR2-LL.H-005.N-T		Camera with housing heating for arctic temperatures and terminal box termination: Equipped with a self-regulating heater. Ambient temperature: -60°C < T _{amb} < +60°C Included accessories: 5 m cable with pre-mounted and pre-wired ex-e terminal box (see Ex-TB3) Product Group: A, tariff number: 8525 8900
Option Mining		Explosion protection (mining): Ex I M2 Ex db I Mb Included accessories: 5 meter armoured cable connected to RJ45 plug
A wide range of mounting accessories...		...can be found on #page_40!

The ExCam IPQ1656 - Powerful PoE Camera with Remote Zoom & Focus and AI



ExCam IP1656
in a stainless steel housing

ExCam IPQ1656

The **ExCam IP1656** is a powerful IP-megapixel camera, approved according to Directive 2014/34/EU (ATEX), IECEx, UKEX, INMETRO, EAC-Ex, It combines excellent image and video performance (**QuadHDTV-resolution 2688x1512**) with outstanding hardware and processing capabilities. It is equipped with a **Deep Learning** Processor Unit (DLPU). Thanks to **Artificial Intelligence (AI)** with Deep Learning it is perfect for **analytic** applications. It can differ between different objects.

Group II (Gas & Dust)	ATEX / IECEx / EAC-Ex					Group I (Mining)	ATEX / IECEx	
Zone	0	1	2	21	22	Category	Ma	Mb
Application	✗	✓	✓	✓	✓	Application	✗	✓

Product / Model	Description	
ExCam IPQ1656 T08-VA2.3.K3.BOR2-N.H-005.N-P 		Network camera in a stainless steel housing in accordance with Directive 2014/34/EU (ATEX), IECEx, EAC-Ex (CR TU) and more. Power supply camera: PoE, IEEE 802.3af / 802.3at Typ 1 Class 3, max. 8.2 W (typical: 5.1 W) Minimal illumination: Color: 0.05 lx, Black/White: 0.01 lx Horizontal angle of view: 100° - 47° Video compression: H.264, H.265 & Motion JPEG Resolution: 2688 x 1512 (QuadHD) Explosion protection (gas): Ex II 2G Ex db IIC T6 Gb Explosion protection (dust): Ex II 2D Ex tb IIIC T80°C Db Protection level: IP 66/68 (IEC / EN 60529) Ambient temperature limit: $-20^{\circ}\text{C} < T_{\text{amb}} < +60^{\circ}\text{C}$ www.samcon.eu/en/products/network/excam-ipq1656/ Product Group: A, tariff number: 8525 8900
ExCam IPQ1656 T08-VA2.3.K3.BOR2-N.H-005.N-T		Camera with terminal box termination: Included accessories: 5 m cable with pre-mounted and pre-wired ex-e terminal box (see Ex-TB3)
ExCam IPQ1656 T08-VA2.3.K3.BOR2-LL.H-005.N-P		Camera with housing heating for arctic temperatures: Equipped with a self-regulating heater to meet extremely low temperature ranges. Explosion protection (gas): Ex II 2G Ex db IIC T5 Gb Explosion protection (dust): Ex II 2D Ex tb IIIC T95°C Db Ambient temperature: $-60^{\circ}\text{C} < T_{\text{amb}} < +60^{\circ}\text{C}$
ExCam IPQ1656 T08-VA2.3.K3.BOR2-LL.H-005.N-T		Camera with housing heating for arctic temperatures and terminal box termination: Equipped with a self-regulating heater. Ambient temperature: $-60^{\circ}\text{C} < T_{\text{amb}} < +60^{\circ}\text{C}$ Included accessories: 5 m cable with pre-mounted and pre-wired ex-e terminal box (see Ex-TB3)
ExCam IPQ1656 T08-VA2.3.K3.BOR2-N.HH-010.N-T 		Camera with cool.Jacket „laminar Flow“ (VA2.3 Series) Aktive cooling system for hot ambient temperatures (surcharge): The cooling element is flooded with cooling water. So the inside temperature is kept below the maximum permitted value of the camera module by the principle of heat exchange. Explosion protection (gas): Ex II 2G Ex db IIC T3 Gb Explosion protection (dust): Ex II 2D Ex tb IIIC T195°C Db Ambient temperature: $-10^{\circ}\text{C} < T_{\text{amb}} < +130^{\circ}\text{C}$ Product group: A, tariff number: 8525 8900
Cooling unit		Mobile cooling unit with integrated flow controller
Valves and Tubes		Solenoid valves and tube packages upon request
Option Mining		Explosion protection (mining): Ex I M2 Ex db I Mb Included accessories: 5 meter armoured cable connected to RJ45 plug
A wide range of mounting accessories...		...can be found on #page_40

The ExCam IPQ1715 - PoE Networkcamera with Motor Zoom, Auto Focus & DLPU







ExCam IPQ1715
in stainless steel housing

ExCam IPQ1715

FullHD resolution meets **Motor Zoom** lens! The **ExCam IPQ1715** is a powerful Motor Zoom- Network-camera approved according to Directive 2014/34/EU (ATEX), IECEx and EAC-Ex. Due to **Power over Ethernet (PoE)** is possible to have only one cable for transmitting data as well as power! The ExCam IPQ1715 delivers several different video streams at the same time and supports **MJPEG, H.265 and H.264 in FullHD resolution** (1920 x 1080 pixels). The integrated DLPU opens up the possibility for various analytical functions.

Group II (Gas & Dust)	ATEX / IECEx / EAC-Ex				
Zone	0	1	2	21	22
Application	✗	✓	✓	✓	✓

Group I (Mining)	ATEX / IECEx..	
Category	Ma	Mb
Application	✗	✓

Product / Model	Description	
ExCam IPQ1715 T08-VA2.2.K1.BOR-L.N-005.N-P 		Network camera in stainless steel housing accordance with Directive 2014/34/EU (ATEX), IECEx, EAC-Ex (CR TU) and more. PoE, IEEE 802.3af Type2, Class 4 (max. 13.5 W, typ. 12.0 W) Minimal illumination: Color: 0.1 lx, Black/White: 0.02 lx Horizontal angle of view: 76° - 3.6° (HD, 16/9) (Motor zoom) Zoom: 21x optical Video compression: H.264, H.265, Motion JPEG Resolution: 1920 x 1080 (FullHD) to 160 x 120 Explosion protection (gas): Ex II 2G Ex db IIB T6 Gb Explosion protection (dust): Ex II 2D Ex tb IIIC T80°C Db Protection level: IP 66/68 (IEC / EN 60529) Ambient temperature: -40°C < T _{amb} < +50°C www.samcon.eu/en/products/network/excam-ipq1715 Produktgruppe: A, Warentarifnummer: 8525 8900
ExCam IPQ1715 T08-VA2.2.K1.BOR-L.N-005.N-T		Camera with terminal box termination: Included accessories: 5 m cable with pre-mounted and pre-wired ex-e terminal box (see Ex-TB3)
ExCam IPQ1715 T08-VA2.2.K1.BOR-LL.H-005.N-P		Camera with housing heating for arctic temperatures: Equipped with a self-regulating heater to meet extremely low temperature ranges. Explosion protection (gas): Ex II 2G Ex db IIB T4 Gb Explosion protection (dust): Ex II 2D Ex tb IIIC T130°C Db Ambient temperature: -60°C < T _{amb} < +50°C
ExCam IPQ1715 T08-VA2.2.K1.BOR-LL.H-005.N-T		Camera with housing heating for arctic temperatures and terminal box termination: Included accessories: 5 m cable with pre-mounted and pre-wired ex-e terminal box (see Ex-TB3)
ExCam IPQ1715 T08-VA2.2.K1.BOR-L.HH-010.N-P		Camera with cool.Jacket „laminar Flow“ (VA2.2 Series) Aktive cooling system for hot ambient temperatures (surcharge): The cooling element is flooded with cooling water. So the inside temperature is kept below the maximum permitted value of the camera module by the principle of heat exchange. Explosion protection (gas): Ex II 2G Ex db IIB T3 Gb Explosion protection (dust): Ex II 2D Ex tb IIIC T195°C Db Ambient temperature: -40°C < T _{amb} < +120°C Product group: A, tariff number: 8525 8900
Cooling unit		Mobile cooling unit with integrated flow controller
Valves and Tubes		Solenoid valves and tube packages upon request
Option Mining		Explosion protection (mining): Ex I M2 Ex db I Mb Included accessories: 5 meter armoured cable connected to RJ45 plug
Further Models...		... with wiper coming soon
A wide range of mounting accessories...		...can be found on #page_40!

The ExCam IPQ1785 - PoE Networkcamera with Motor Zoom & Auto Focus in FullHD









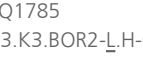

ExCam IPQ1785
in stainless steel housing

ExCam IPQ1785

FullHD resolution meets super **motor zoom** lens! The **ExCam IPQ1785** is a network camera with motor zoom, approved according to Directive 2014/34/EU (ATEX), IECEx, and EAC-Ex. Due to **Power over Ethernet (PoE)** is possible to have only one cable for transmitting data as well as power! The ExCam IPQ1785 delivers several different video streams at the same time and supports **MJPEG and H.264 in 2 Megapixel resolution** of 1920 x 1080 pixels.

Group II (Gas & Dust)	ATEX / IECEx / EAC-Ex					Group I (Mining)	ATEX / IECEx..	
Zone	0	1	2	21	22	Category	Ma	Mb
Application	✗	✓	✓	✓	✓	Application	✗	✓

Product / Model	Description	
ExCam IPQ1785 T08-VA2.3.K3.BOR2-N.H-005.N-P 		Network camera in stainless steel housing accordance with Directive 2014/34/EU (ATEX), IECEx, and EAC-Ex (CR TU) PoE, IEEE 802.3af Type1, Class 3 (max. 12.95 W, typ. 7.7 W) Minimal illumination: Color: 0.16 lx, Black/White: 0.03 lx Horizontal angle of view: 60° - 2.3° (HD, 16/9) (motor zoom) Zoom: 32x optical, 12x digital Video compression: H.264 (MPEG-4 Part 10/AVC), Motion JPEG Resolution: 1920 x 1200 (WUXGA) to 160 x 90 Explosion protection (gas): Ex II 2G Ex db IIC T6 Gb Explosion protection (dust): Ex II 2D Ex tb IIIC T80°C Db Protection level: IP 66/68 (IEC / EN 60529) Ambient temperature: -10°C < T _{amb} < +60°C www.samcon.eu/en/products/network/excam-ipq1785/ Product group: A, tariff number: 8525 8900
ExCam IPQ1785 T08-VA2.3.K3.BOR2-N.H-005.N- <u>I</u>		Camera with terminal box termination: Included accessories: 5 m cable with pre-mounted and pre-wired ex-e terminal box (see Ex-TB3)
ExCam IPQ1785 T08-VA2.3.K3.BOR2- <u>L</u> .H-005.N-P 		Camera with housing heating for low temperatures: Equipped with a self-regulating heater. Explosion protection (gas): Ex II 2G Ex db IIC T5 Gb Explosion protection (dust): Ex II 2D Ex tb IIIC T95°C Db Ambient temperature: -30°C < T _{amb} < +60°C Product group: A, tariff number: 8525 8900
ExCam IPQ1785 T08-VA2.3.K3.BOR2- <u>L</u> .H-005.N- <u>I</u>		Camera with housing heating for low temperatures and terminal box termination: Equipped with a self-regulating heater. Ambient temperature: -30°C < T _{amb} < +60°C Included accessories: 5 m cable with pre-mounted and pre-wired ex-e terminal box (see Ex-TB3)
ExCam IPQ1785 T08-VA2.3.K3.BOR5- <u>LL</u> .H-005.N-P 		Network camera in stainless steel housing with wiper and housing heating for arctic temperatures: Equipped with a wiper and a self-regulating heater to meet extremely low temperature ranges. Ambient temperature: -60°C < T _{amb} < +60°C www.samcon.eu/en/products/network/excam-ipq1785/ Product group: A, tariff number: 8525 8900

Product / Model		Description
ExCam IPQ1785 T08-VA2.3.K3.BOR5-LL.H-005.N-I		Camera with wiper, housing heating for arctic temperatures and terminal box termination: equipped with a wiper and a self-regulating heater to meet extremely low temperature ranges. Ambient temperature: $-60^{\circ}\text{C} < T_{\text{amb}} < +60^{\circ}\text{C}$ Included accessories: 5 m cable with pre-mounted and pre-wired ex-e terminal box (see Ex-TB3)
ExCam IPQ1785-W (Wash & Wipe) T08-VA2.3.K3.BOR5-LL.H-010.N-015.O-P 		Network camera in stainless steel housingn accordance with Directive 2014/34/EU (ATEX), IECEx, and EAC-Ex (CR TU) equipped with a self regulating heater, wiper and a plug & play cable to connect the cam.Cleaner PoE, IEEE 802.3af Type1, Class 3 (max. 12.95 W, typ. 7.7 W) Minimal illumination: Color: 0.16 lx, Black/White: 0.03 lx Horizontal angle of view: 60° - 2.3° (HD, 16/9) (motor zoom) Zoom: 32x optical, 12x digital Video compression: H.264 (MPEG-4 Part 10/AVC), Motion JPEG Resolution: 1920 x 1200 (WUXGA) to 160 x 90 Explosion protection (gas): Ex II 2G Ex db IIC T5 Gb Explosion protection (dust): Ex II 2D Ex tb IIIC T95°C Db Protection level: IP 66/68 (IEC / EN 60529) Ambient temperature: $-60^{\circ}\text{C} < T_{\text{amb}} < +60^{\circ}\text{C}$ www.samcon.eu/en/products/network/excam-ipq1785/ Product group: A, tariff number: 8525 8900
Option Mining		Explosion protection (mining): Ex I M2 Ex db I Mb Included accessories: 5 meter armoured cable connected to RJ45 plug
A wide range of mounting accessories...	can be found on #page_40!

The ExCam IPP3827 - 180° Panorama Network Camera with 7 MP Resolution















ExCam IPP3827
in a stainless steel housing

ExCam IPP3827

Keep an eye on the big picture: **180° panoramic view** network camera with **7MP** resolution for monitoring large areas. The **ExCam IPP3827** is a powerful **multi-sensor camera**, particularly suitable for use in potentially explosive areas. It offers 7MP resolution (3712 x 1856, 7 MP@30fps) and 4 1/2.8" sensors for **seamless 180° coverage**. The individual images captured by the 4 sensors are stitched together to form a seamless overall image, delivering real-time 180° images with HD resolution, with no blind spots. It is approved according to **Directive 2014/34/EU (ATEX), IECEx, INMETRO, EAC-Ex** and more.

Group II (Gas & Dust)	ATEX / IECEx/ EAC-Ex					Group I (mining)	-	
Zone	0	1	2	21	22	Category	Ma	Mb
Application	✗	✓	✓	✓	✓	Application	✗	✗

Product / Model	Description	
ExCam IPP3827 T08-VA4.1K.PS1-LL.H-000.X-X 	           	Network multi-sensor-camera in a stainless steel housing in accordance with Directive 2014/34/EU (ATEX), IECEx, EAC-Ex (CR TU) and more. PoE+, IEEE 802.3at, Type2, Class 4 (typical 12 W, max. 18 W) Minimum illumination: color: 0.15 lx, b/w: 0.05 lx Horizontal angle of view: 180° - 90° Resolution: 3712 x 1856 (7 MP) Functions: Preset positions, guard tours, sharpness, contrast, etc... Explosion protection (gas): Ex II 2G Ex db IIC T6 Gb Explosion protection (dust): Ex II 2D Ex tb IIIC T80°C Db Protection level: IP 66/68 (IEC / EN 60529) Ambient temperature: -50°C < T _{amb} < +60°C www.samcon.eu/en/products/network/excam-ipp3827/ Product group: A, tariff number: 8525 8900
ExCam IPP3827 T08-VA4.1K.PS1-LL.H-005.N-P		Camera with plug termination: Included accessories: 5 m cable with plug termination
ExCam IPP3827 T08-VA4.1K.PS1-LL.H-005.N-T		Camera with terminal box termination: Included accessories: 5 m cable with pre-mounted and pre-wired ex-e terminal box (see Ex-TB3)
A wide range of mounting accessories...	can be found on #page 40!

new! The ExCam IPP5655 MKII - PoE Network Dome Camera with 32x Motor Zoom & FullHD





ExCam IPP5655 MKII
 in a stainless steel housing

ExCam IPP5655 MKII

The **ExCam IPP5655 MKII** is a powerful network dome camera which can deliver 2 megapixel resolution at 1920 x 1080p points. It is certified in accordance with Directive 2014/34/EU (ATEX), IECEx, and more. The camera can continuous turn on its own axis. The picture is automatically turned very precisely and rapidly. **Outstanding optical, electronical and mechanical features** are combined in this camera. The compact housing with the optimized dome is new and unique.

Group II (Gas & Dust)	ATEX / IECEx/ EAC-Ex					Group I (mining)	-	
Zone	0	1	2	21	22	Category	Ma	Mb
Application	✗	✓	✓	✓	✓	Application	✗	✗

Product / Model	Description	
ExCam IPP5655 MKII T08-VA4.1K.PS1-L.H-005.N-P 		Network dome camera in a stainless steel housing in accordance with Directive 2014/34/EU (ATEX), IECEx, EAC-Ex (CR TU) and more. PoE+, IEEE 802.3at, Typ 2 Category 4 (typical 10.5 W, max. 19 W) Minimum illumination: 0.1 lx (Color), 0.02 lx (B/W) Horizontal angle: 58.3° - 2.4° (HD, 16/9) Zoom: 32x optical zoom, 12x digital zoom Pan: 360° continuously, 0.1° – 350°/s Tilt: 160°@58,3°FoV, 0.1° – 350°/s Resolution: 1920 x 1080 bis 320 x 180 Functions: Preset positions, guard tours, sharpness, contrast, etc... Explosion protection (gas): Ex II 2G Ex db IIC T6 Gb Explosion protection (dust): Ex II 2D Ex tb IIIC T80°C Db Protection level: IP 66/68 (IEC / EN 60529) Ambient temperature: -30°C < T _{amb} < +60°C www.samcon.eu/en/products/network/excam-ipp5655-mkii/ www.samcon.eu, product group: A, tariff number: 8525 8900
ExCam IPP5655 MKII T08-VA4.1K.PS1-L.H-005.N-T		Camera with terminal box termination: Included accessories: 5 m cable with pre-mounted and pre-wired ex-e terminal box (see Ex-TB3)
A wide range of mounting accessories...	can be found on #page_40!

The ExCam IPQ6075 - PoE Network Dome Camera with 40x Motor Zoom & FullHD

















ExCam IPQ6075
in a stainless steel housing

ExCam IPQ6075

The **ExCam IPQ6075** is a powerful network dome camera which can deliver 2 megapixel resolution at 1920 x 1080p points. It is certified in accordance with Directive 2014/34/EU (ATEX), IECEx, and EAC-Ex. The camera can continuous turn on its own axis. The picture is automatically turned very precisely and rapidly. **Outstanding optical, electronical and mechanical features** are combined in this camera.

Group II (Gas & Dust)	ATEX / IECEx/ EAC-Ex				
Zone	0	1	2	21	22
Application	✗	✓	✓	✓	✓

Group I (mining)	-	
Category	Ma	Mb
Application	✗	✗

Product / Model	Description	
ExCam IPQ6075 T08-TNXCD-N.H-005.N-P 	           	Network dome camera in a stainless steel housing in accordance with Directive 2014/34/EU (ATEX), IECEx, EAC-Ex (CR TU) and more. PoE+, IEEE 802.3at, Typ 2 Category 4 (typical 11 W, max. 17.1 W) Minimum illumination: 0.1 lx (Color), 0.002 lx (B/W) Horizontal angle: 65.1° - 2.0° (HD, 16/9) Zoom: 40x optical zoom, 12x digital zoom Pan: 360° continuously, 0.1° - 350°/s Tilt: 166°@65.1°FoV, 0.1° - 350°/s Resolution: 1920 x 1080 bis 320 x 180 Functions: Preset positions, guard tours, sharpness, contrast, etc... Explosion protection (gas): Ex II 2G Ex db IIC T6 Gb Explosion protection (dust): Ex II 2D Ex tb IIIC T80°C Db Protection level: IP 66/68 (IEC / EN 60529) Ambient temperature: 0°C < T _{amb} < +60°C www.samcon.eu/en/products/network/excam-ipq6075/ www.samcon.eu, product group: A, tariff number: 8525 8900
ExCam IPQ6075 T08-TNXCD-N.H-005.N- <u>I</u>		Camera with terminal box termination: Included accessories: 5 m cable with pre-mounted and pre-wired ex-e terminal box (see Ex-TB3)
ExCam IPQ6075 T08-TNXCD- <u>LL</u> .H-005.N-P 		Camera with housing heating for arctic temperatures: Equipped with a self-regulating heater to meet extremely low temperature ranges. Ambient temperature: $-50^{\circ}\text{C} < T_{\text{amb}} < +60^{\circ}\text{C}$
ExCam IPQ6075 T08-TNXCD- <u>LL</u> .H-005.N- <u>I</u>		Camera with housing heating for arctic temperatures and terminal box termination: Equipped with a self-regulating heater to meet extremely low temperature ranges. Includes two cable glands certified for -60°C with integrated pressure barrier: Ambient temperature: $-50^{\circ}\text{C} < T_{\text{amb}} < +60^{\circ}\text{C}$ Included accessories: 5 m cable pre-mounted and pre-wired to an ex-e terminal box (see Ex-TB3)
A wide range of mounting accessories...	can be found on #page_40!

The ExCam IPP1280 - Ultra Compact Thermal Network Camera





ExCam IPP1280
in stainless steel housing

ExCam IPP1280

The **ExCam IPP1280** is a **thermal** network camera, approved according to Directive 2014/34/EU (ATEX), IECEx & EAC-Ex. It is an **ultra compact** camera for use in hazardous areas – offering all advantages of thermal detection. The ExCam IPP1280 is a **modular** Ex-Network-Camera. This means that it consists of two units: the ultra compact **sensor unit** (lens and image sensor) and the **main unit** (network, power and memory card slot). It is ultra compact and cost effective.

Group II (Gas & Dust)	ATEX / IECEx / EAC-Ex				
Zone	0	1	2	21	22
Application	✗	✓	✓	✓	✓

Group I (Mining)	ATEX / IECEx...	
Category	Ma	Mb
Application	✗	✗

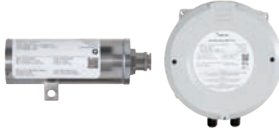
Product / Model	Description	
ExCam IPP1280 T08-VA0.1.K1.GER-N.N-005.N-P 		Modular thermal network camera: Sensor Unit in stainless steel housing in accordance with Directive 2014/34/EU (ATEX), IECEx and EAC-Ex. Main Unit P12 MkII for safe areas PoE, IEEE 802.3af/802.3at Type1 Class 2 (typ. 2.5 W, max. 4 W) Uncooled microbolometer, spectral range 8 µm to 14 µm (this corresponds to a scale of temperature of radiation from -66°C to 89°C) Horizontal angle of view: 35.4° Resolution: 208 x 156 Explosion protection (gas): Ex II 2G Ex db IIC T6 Gb Explosion protection (dust): Ex II 2D Ex tb IIIC T80°C Db Protection Level (Sensor Unit): IP 66/68 (IEC / EN 60529) Protection Level (Main Unit): IP 66 (IEC / EN 60529) Ambient temperature Sensor Unit: -30°C < T _{amb} < +60°C Ambient temperature Main Unit: -20°C < T _{amb} < +50°C www.samcon.eu/en/products/network/excam-ipp1280/ Product group: A, tariff number: 8525 8900
ExCam IPP1280 T08-VA0.1.K1.GER-N.N-005.N-TD 		Modular thermal network camera: Sensor Unit in stainless steel housing, Main Unit P12 MkII in Ex-d housing in accordance with Directive 2014/34/EU (ATEX) and IECEx. Explosion protection Sensor Unit (gas): Ex II 2G Ex db IIC T6 Gb Explosion protection Sensor Unit (dust): Ex II 2D Ex tb IIIC T80°C Db Explosion protection Main Unit (gas): Ex II 2G Ex d IIC T6 Gb Explosion protection Main Unit (dust): Ex II 2D Ex tb IIIC T80°C Db Protection Level (Sensor Unit): IP 66/68 (IEC / EN 60529) Protection Level (Main Unit): IP 66 (IEC / EN 60529) Ambient temperature Sensor Unit: -30°C < T _{amb} < +60°C Ambient temperature Main Unit: -20°C < T _{amb} < +50°C Product group: A, tariff number: 8525 8900
A wide range of mounting accessories...		...can be found on #page_40!

The ExCam XI80 - Thermal Camera with Auto Focus and Infrared-Thermometer



ExCam XI80
in stainless steel housing

ExCam XI80

The **ExCam XI80** is a powerful **thermographic** camera with an integrated **infrared thermometer** and **auto focus** for use in potentially explosive areas. It delivers excellent infrared images (80x80p) in a temperature range from -20°C to 900°C. In addition, the thermal imaging camera has extensive analysis functions (e.g. thermal analysis with **hot and cold spots**). The Excam XI80 can not only see where it is hot, it can also measure the temperature exactly; and all that in an 8 millisecond interval (Real Time Recording).

Group II (Gas & Dust)	ATEX / IECEx / EAC-Ex				
Zone	0	1	2	21	22
Application	✗	✓	✓	✓	✓

Group I (Mining)	ATEX / IECEx...	
Category	Ma	Mb
Application	✗	✗

Product / Model	Description	
ExCam XI80 T08-VA0.4.K1.GER-N.N-005.N-P 		Thermal camera in stainless steel housing in accordance with Directive 2014/34/EU (ATEX), IECEx and EAC-Ex. Power supply: 10-30V DC; Power consumption: max. 2.5 W Uncooled microbolometer, spectral range 8 µm to 14 µm Temperature range: -20°C to 100°C, 0°C to 250°C, 450°C to 900°C Thermal sensitivity: 100 mK Optic: 12°, 30°, 55° (standard) or 80° Optical resolution: 80 x 80p Explosion protection (gas): Ex II 2G Ex db IIC T6 Gb Explosion protection (dust): Ex II 2D Ex tb III C T80°C Db Protection level: IP 66/68 (IEC / EN 60529) Ambient temperature: -10°C < T _{amb} < +50°C www.samcon.eu/en/products/network/excam-xi80/ Product group: A, tariff number: 9025 1900
ExCam XI80 T08-VA0.4.K1.GER-N.N-005.N-I		Thermal camera with terminal box termination Included accessories: 5 m cable pre-mounted and pre-wired to an ex-e terminal box (see Ex-TB3) Product group: A, tariff number: 9025 1900
PIF Industrial Process Interface 		High performance extension for the analog and digital alarm in- and outputs to allow 3 additional in- and outputs of each, without cable for aligned mount of up to 3 PIFs in connecting box IP65, for applications in safe areas, 500 VACeff isolation voltage between camera and process Analog outputs: 3x 0/4...20mA or 0...10V Digital outputs: 3x relays max. 30V/ 400mA Analog or digital inputs: 3x 0...10V or 24V Fail-safe-output: 1x relay max. 30V/ 400mA Power supply: 24VDC Ambient temperature: -30°C...+85°C Product group: C, tariff number: 9025 9000
A wide range of mounting accessories...	can be found on #page_40!

The ExCam XI410 - Thermal Camera with Motor Focus and Infrared-Thermometer



ExCam XI410
in stainless steel housing

ExCam XI410

The **ExCam XI410** is a powerful **thermographic** camera with an integrated **infrared thermometer** and **motor focus** for use in potentially explosive areas. It delivers excellent infrared images (384x240p) of measuring objects in a temperature range from -20°C to 900°C. In addition, the thermal imaging camera has extensive analysis functions (e.g. thermal analysis with **hot and cold spots**). The Excam XI410 can not only see where it is hot, it can also measure the temperature exactly.

Group II (Gas & Dust)	ATEX / IECEx / EAC-Ex					Group I (Mining)	ATEX / IECEx...	
Zone	0	1	2	21	22	Category	Ma	Mb
Application	✗	✓	✓	✓	✓	Application	✗	✗

Product / Model	Description	
ExCam XI410 T08-VA0.4.K1.GER-N.N-005.N-P 	         	Thermal camera in stainless steel housing in accordance with Directive 2014/34/EU (ATEX), IECEx and EAC-Ex. Power supply: 10-30V DC; Power consumption: max. 2.5 W Uncooled microbolometer, spectral range 8 µm to 14 µm Temperature range: -20°C to 100°C, 0°C to 250°C, 450°C to 900°C Thermal sensitivity: 80 mK Optic: 18°, 29°, 53° (standard) or 80° Optical resolution: 384 x 240p Explosion protection (gas): Ex II 2G Ex db IIC T6 Gb Explosion protection (dust): Ex II 2D Ex tb IIIC T80°C Db Protection level: IP 66/68 (IEC / EN 60529) Ambient temperature: -10°C < T _{amb} < +50°C www.samcon.eu/en/products/network/excam-xi410 Product group: A, tariff number: 9025 1900
ExCam XI410 T08-VA0.4.K1.GER-N.N-005.N-I		Thermal camera with terminal box termination Included accessories: 5 m cable pre-mounted and pre-wired to an ex-e terminal box (see Ex-TB3) Product group: A, tariff number: 9025 1900
PIF Industrial Process Interface 		High performance extension for the analog and digital alarm in- and outputs to allow 3 additional in- and outputs of each, without cable for aligned mount of up to 3 PIFs in connecting box IP65, for applications in safe areas, 500 VACeff isolation voltage between camera and process Analog outputs: 3x 0/4...20mA or 0...10V Digital outputs: 3x relays max. 30V/ 400mA Analog or digital inputs: 3x 0...10V or 24V Fail-safe-output: 1x relay max. 30V/ 400mA Power supply: 24VDC Ambient temperature: -30°C...+85°C Product group: C, tariff number: 9025 9000
A wide range of mounting accessories...	can be found on #page_40!

You cannot find a suitable ex-proof camera or you want a certain camera modul, upon request we build your desired ExCam (**BTO**). Please ask us and visit our homepage www.samcon.eu/en/products/bto/

Modular Ex Cameras - Sensor Units and Main Units



ExCam SUFA4115 + SUFA1080
 connected to **ExCR FA54**

Modular Ex Cameras

Our flexible modular high-performance ATEX-cameras are based on a divided network camera concept. The cameras consist of two separate elements which can be combined very flexibly: an ultra compact sensor unit (SU) to capture images and a main unit (MU) for image processing and network connection. These two units can be placed separately. The sensor unit can be mounted in even the smallest installation space while the main unit can be installed where more space is available. One main unit can send Full frame rate HDTV1080p streams of up to 4 sensor units.



Group II (Gas & Dust)	ATEX / IECEx/ EAC-Ex				
	Zone 0	1	2	21	22
Application	✗	✓	✓	✓	✓

Group I (mining)	-	
	Ma	Mb
Application	✗	✗

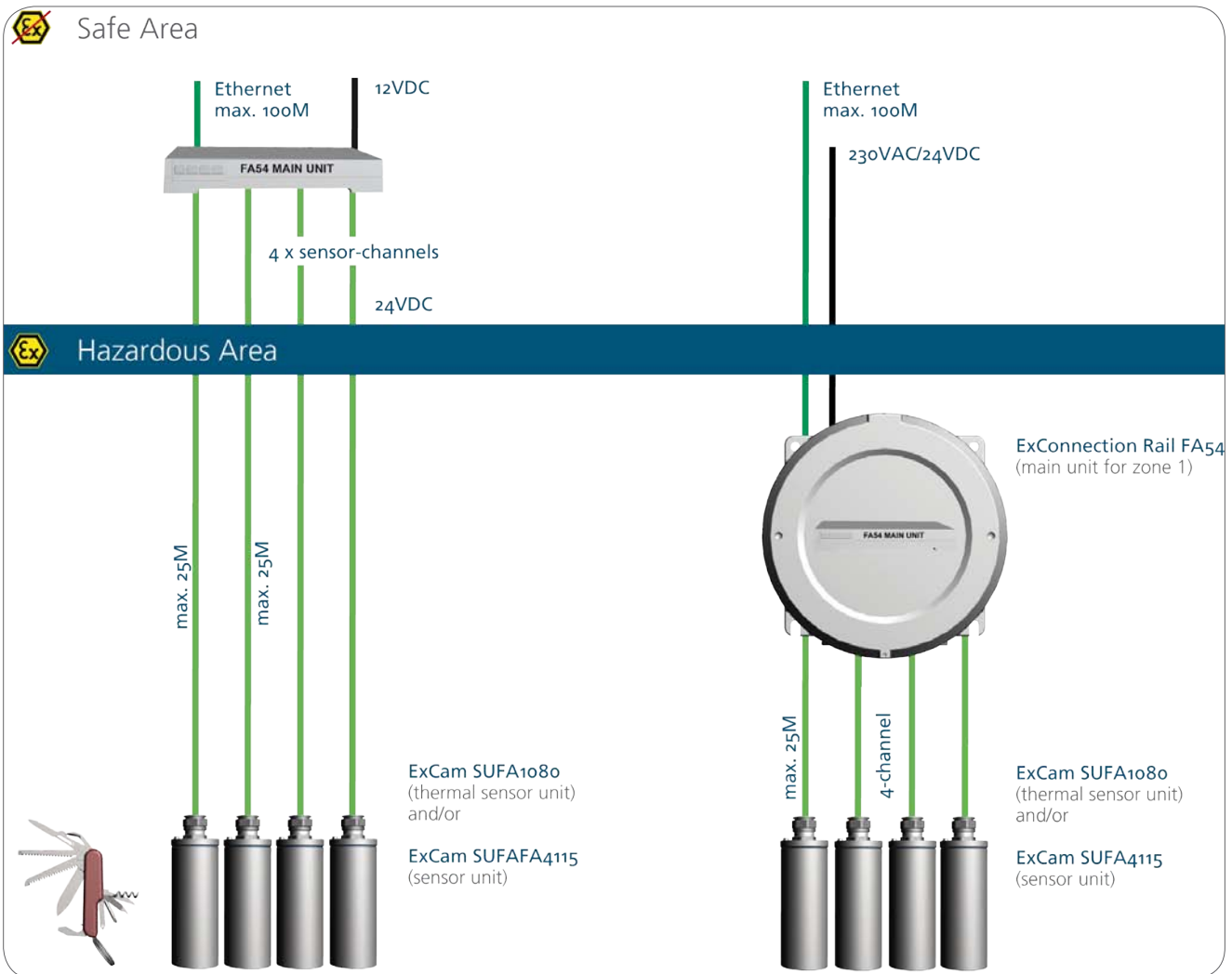
Connection options (up to 4 sensor units simultaneous)



Product / Model		Description
ExCam SUFA4115 T08-VA0.1.K1.BOR-N.N-005.N-P 		Sensor unit in a stainless steel housing in accordance with Directive 2014/34/EU (ATEX), IECEx and EAC-Ex. Minimum illumination: colour: 0.2 lx Horizontal angle of view: 82° - 53° Resolution: 1920 x 1080 (1080p) Power supply via ExCR FA54 (4VDC) (not included) Power consumption: typ. 0.5 W, max. 1.2 W Explosion protection (gas): Ex II 2G Ex db IIC T6 Gb Explosion protection (dust): Ex II 2D Ex tb IIIC T80°C Db Protection level: IP 66/68 (IEC / EN 60529) Ambient temperature: $-20^{\circ}\text{C} < T_{\text{amb}} < +50^{\circ}\text{C}$ Required hardware: ExConnection Rail FA54 or FA54 Main Unit Included accessories: 5 m cable with RJ12 plug. www.samcon.eu/en/products/network/modular/excam-sufa4115 Product group: A, tariff number: 8525 8900
ExCam SUFA1080 T08-VA0.1.K1.GER-N.N-005.N-P 		Thermal sensor unit in a stainless steel housing in accordance with Directive 2014/34/EU (ATEX), IECEx and EAC-Ex. Uncooled microbolometer Spectral range: 8 μm to 14 μm (corresponds to -66°C to 89°C) Horizontal angle: 35.4° Resolution: 208 x 156 (12 μm) Power supply via ExCR FA54 (4VDC) (not included) Power consumption: typ. 0.5 W, max. 1.2 W Explosion protection (gas): Ex II 2G Ex db IIC T6 Gb Explosion protection (dust): Ex II 2D Ex tb IIIC T80°C Db Protection level: IP 66/68 (IEC / EN 60529) Ambient temperature: $-30^{\circ}\text{C} < T_{\text{amb}} < +60^{\circ}\text{C}$ Required hardware: ExConnection Rail FA54 or FA54 Main Unit Included accessories: 5 m cable with RJ12 plug. www.samcon.eu/en/products/network/modular/excam-sufa1080 Product group: A, tariff number: 8525 8900
ExConnection Rail FA54 T04.4-D-4SU-24 		Main unit FA54 for visualization of the FA sensor units in pressure resistant housing for wall mount. Explosion protection according to Directive 2014/34/EU (ATEX), IECEx & EAC-Ex Explosion protection (gas): Ex II 2G Ex db IIC T6 Gb Explosion protection (dust): Ex II 2D Ex tb IIIC T80°C Db Protection level: IP 66 (IEC / EN 60529) Ambient temperature: $-30^{\circ}\text{C} < T_{\text{amb}} < +50^{\circ}\text{C}$ Dimensions: 236 x 236 x 227 mm Input voltage: 18 VDC - 75 VDC Power consumption: 43.2 W (max) www.samcon.eu/en/products/network/modular/excr-fa54 Product group: B, tariff number: 8517 6200
ExConnection Rail FA54 T04.4-D-4SU-230 		Main unit FA54 for visualization of the FA sensor units in pressure resistant housing for wall mount. Explosion protection according to Directive 2014/34/EU (ATEX), IECEx & EAC-Ex Explosion protection (gas): Ex II 2G Ex db IIC T6 Gb Explosion protection (dust): Ex II 2D Ex tb IIIC T80°C Db Protection level: IP 66 (IEC / EN 60529) Ambient temperature: $30^{\circ}\text{C} < T_{\text{amb}} < +50^{\circ}\text{C}$ Dimensions: 236 x 236 x 227 mm Input voltage: 100 VAC - 240 VAC Power consumption: 43.2 W (max) www.samcon.eu/en/products/network/modular/excr-fa54 Product group: B, tariff number: 8517 6200
... see next page for further options		

Product / Model	Description	
<p>FA54 Main Unit</p> 		<p>Main unit FA54 for visualization of the FA sensor units for use in safe areas</p> <ul style="list-style-type: none"> Basis unit for 4 sensor units Compatible with all SUFA sensor units Resolution: 1080p Full HD resolution @ 25fps, 720p @ 50fps Forensic WDR optimizes for moving objects Quad-View-Streaming Video compression: H.264 with Axis Zipstream Technology HDMI output for local monitor Two SDXC card slots for Edge Storage In-/output for external connection Power supply: 12V DC
<p>A wide range of mounting accessories...</p>		<p>... can be found on #Seite_40!</p>

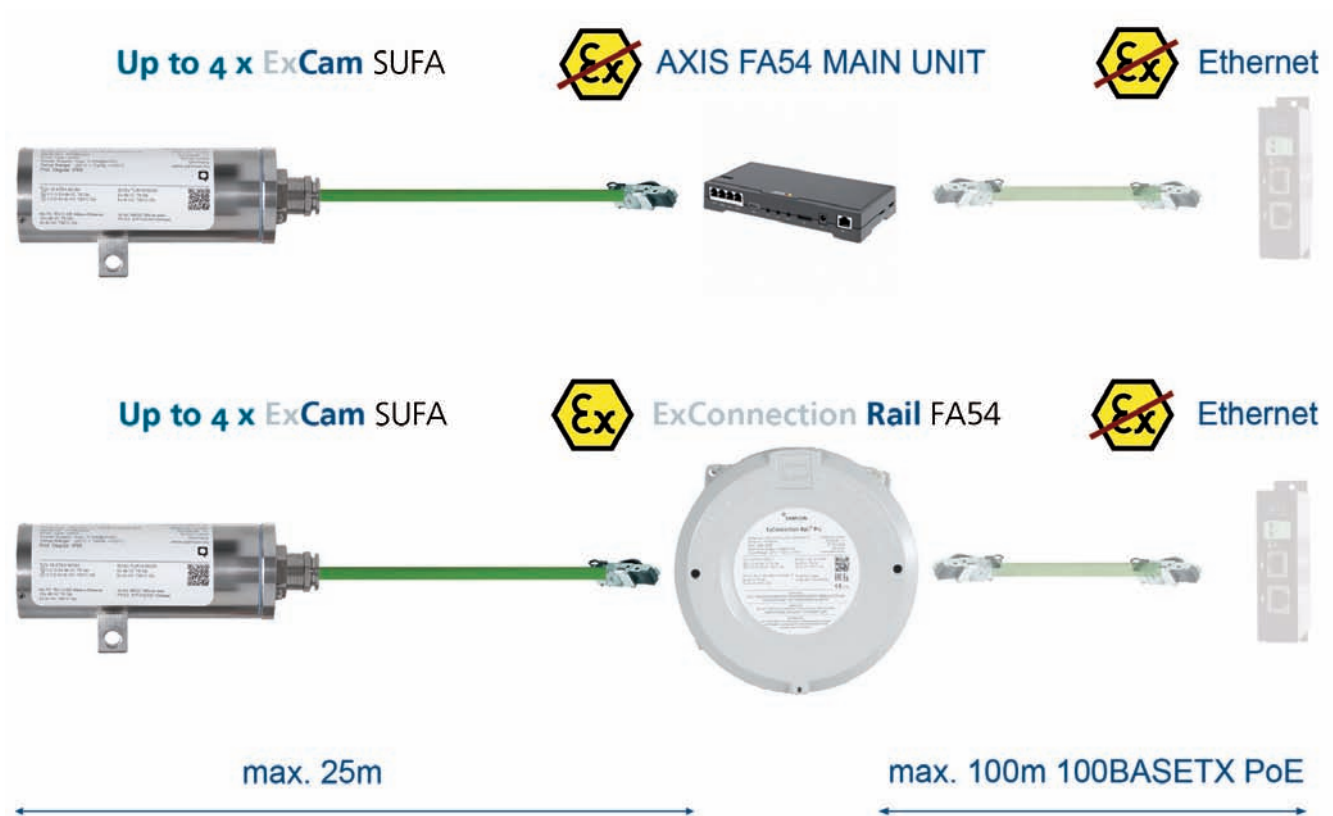

The RoughCam Series - Extreme Robust Cameras for Safe Areas and Sterile Rooms



RoughCam IPM3016 und IP1365
in stainless steel









































RoughCam Series

Our **RoughCam Series** comprises mechanically process as well as security cameras which are extremely robust. All **RoughCams** meet the same high quality standards as our ExCams and are therefore perfect for even the roughest industrial conditions. The stainless steel housing in combination with borosilicate glass and high-end sealings make our **RoughCams** resistant to nearly all media; withstanding even the highest mechanical demands.















Group II (Gas & Dust)	-					Group I (Mining)	-	
Zone	0	1	2	21	22	Category	Ma	Mb
Application	✗	✗	✗	✗	✗	Application	✗	✗

Product / Model	Description	
RoughCam miniTube T10-VA0.1.K1.BOR-N.N-005.N-P 	IP66 IP68 -10°C +50°C	Multisignal camera in a stainless steel housing (IP66/68) Minimal illumination: 0.01 lx @ F1.2 Angle of view: 80° (HD, 16/9, standard), optional 56° or 41° Resolution: 1920x1080 (FullHD) Ambient temperature: $-10^{\circ}\text{C} < T_{\text{amb}} < +50^{\circ}\text{C}$ Product group: B, tariff number: 8525 8900
RoughCam e.Vario T10-VA1.2.K1.BOR-L.N-005.N-X 	IP66 IP68 -40°C +50°C	Varifocal camera in a stainless steel housing (IP66/68) equipped with motorized varifocal lens Minimal illumination: 0.5 lx (color), 0.1 lx (b/w) Angle of view: 65° (wide) to 31° (tele) Day/night function within IR cut filter Power supply: 14VDC to 30VDC Max. power: 2.64W Ambient temperature limit: $-40^{\circ}\text{C} < T_{\text{amb}} < +50^{\circ}\text{C}$ See data sheet for technical data - www.samcon.eu Product group: B, tariff number: 8525 8900
RoughCam IPM3016 T10-VA1.2.K1.BOR-N.N-005.N-P-090 	IP66 IP68 -20°C +55°C HD 720p Onvif	Network camera in a stainless steel housing (IP66/68) Minimal illumination: 0.35 lx at 50 IRE F2.4 Horizontal angle: 90° fix @16/9 Resolution: 2016 x 1512 to 320 x 240 (4:3) or 2304 x 1296 to 640 x 360 (16:9) Ambient temperature limit: $-20^{\circ}\text{C} < T_{\text{amb}} < +55^{\circ}\text{C}$ Product group: B, tariff number: 8525 8900
RoughCam miniTube IP T10-VA1.2.K1.BOR-N.N-005.N-P 	IP66 IP68 -30°C +50°C Onvif HD 1080p	Network camera in a stainless steel housing (IP66/68) Minimal illumination: 0,0008 lx bei 40 IRE F1.6 Horizontal angle of view: 80° - 32° Resolution: 1920 x 1080 (FullHD) Remote Zoom: 4x Ambient temperature limit: $-30^{\circ}\text{C} < T_{\text{amb}} < +50^{\circ}\text{C}$ Product group: B, tariff number: 8525 8900
RoughCam IPM2036 T10-VA2.0.K1.BOR-LL.H-005.N-P-085 	IP66 IP68 -60°C +60°C QHD 1440p Onvif	Network camera in a stainless steel housing (IP66/68) PoE, IEEE 802.3af/802.3at Type 1 Class 3 (max. 12.95 W, typ. 5.0 W) Minimal illumination: 0.18 lx (color), 0.04 lx (b/w) at 50 IRE F2.1; 0 lx with active IR illumination (max. range of reach 2m) Horizontal angle of view: 85° (wide) fix@16/9, [alternative lenses 56° (normal), 41° (tele)] Video compression: H.264 (MPEG-4 Part 10/AVC) Main and High Profiles H.265 (MPEG-H Part 2/HEVC) Main Profile Motion JPEG Resolution: 2304 x 1728 to 320 x 240 (4:3) or 2668 x 1512 to 640 x 360 (16:9) Ambient temperature limit: $-60^{\circ}\text{C} < T_{\text{amb}} < +60^{\circ}\text{C}$ Product group: B, tariff number: 8525 8900

RoughCam Series

Product / Model		Description
RoughCam IPM1137-LE-WL T10-VA2.2.K1.BOR-L.H-005.N-P 	     	Network camera in a stainless steel housing. Equipped with external LED spotlight (white light) in stainless steel housing, switchable via web interface Camera RoughCam IPM1137: PoE, IEEE 802.3af/802.3at Type2 Class4 (max. 25.5W, typ. 19.5W) Minimal illumination: color: 0.17 lx at 50 IRE F1.4; b/w: 0.03 lx Horizontal angle of view: 103° - 31° Resolution: 2592 x 1944 (5MP); Remote zoom and focus with i-CS Protection level: IP 66/68 (IEC / EN 60529) Ambient temperature range: $-30^{\circ}\text{C} < T_{\text{amb}} < +60^{\circ}\text{C}$ LED-lighting liteServer Rough.micro 24.WL.90: High Power 12.5W COB LED; 12.9W@24VDC Luminous flux: max. 1930lm; beam angle: 90° Color temperature: 5000K (white light) Protection level: IP 66/68 (IEC / EN 60529) Ambient temperature range: $-30^{\circ}\text{C} < T_{\text{amb}} < +50^{\circ}\text{C}$ Product group: B, tariff number: 8525 8900/9405 4910
RoughCam IPM1137-LE-IR T10-VA2.2.K1.BOR-L.H-005.N-P	     	Camera-lighting-combination (infrared light) (IP66/68) IR-LED-lighting liteServer Rough.micro 24.IR.90: High Power 12W SMD IR-LED; 12.7W@24VDC Luminous flux: max. 4210mW; beam angle: 90° IR centroid wavelength: 850nm Ambient temperature range: $-30^{\circ}\text{C} < T_{\text{amb}} < +50^{\circ}\text{C}$ Product group: B, tariff numbers: 8525 8900/ 9405 4910
RoughCam IPP1275 T10-VA0.1.K1.BOR-N.N-005.N-P 	     	Modular network camera: Sensor Unit in stainless steel housing. Main Unit P12 MkII PoE, IEEE 802.3af/802.3at Type1 Class 2 (typ. 3.4 W, max. 4.1 W) Minimal illumination: 0.22 lx, F2.0 Horizontal angle of view: 82° - 53° Resolution: 1920 x 1080 Functions: Fixed lens, Variofocus, 2.8 mm to 6 mm Protection Level (Sensor-/Main Unit): IP 68/IP66 (IEC / EN 60529) Ambient temperature: $-20^{\circ}\text{C} < T_{\text{amb}} < +50^{\circ}\text{C}$ Product group: B, tariff number: 8525 8900
RoughCam IPP1377 T10-VA2.3.K3.BOR2-N.H-005.N-P 	     	Network camera in a stainless steel housing. PoE, IEEE 802.3af / 802.3at Type 1 Classe 3 (max. 10.7 W, typ. 5.4 W) Minimum illumination: Color: 0.13 lx, F1.2, B/W: 0.03 lx, F1.2 Horizontal angle of view: 103° - 38° (HD, 16/9) Resolution: 2592 x 1944 (5 Megapixel) to 160 x 90 Protection level: IP 66/68 (IEC / EN 60529) Ambient temperature: $-10^{\circ}\text{C} < T_{\text{amb}} < +60^{\circ}\text{C}$ Product group: B, tariff number: 8525 8900
RoughCam IPQ1656 T10-VA2.3.K3.BOR2-N.H-005.N-P 	     	Network camera in a stainless steel housing. PoE, IEEE 802.3af / 802.3at Type 1 Class 3 (max. 8.2 W typ. 5.1 W) Minimum illumination: Color: 0.05 lx, Black/White: 0.01 lx Horizontal angle of view: 100° - 47° Resolution: 2688 x 1512 (QuadHD) Protection level: IP 66/68 (IEC / EN 60529) Ambient temperature: $-20^{\circ}\text{C} < T_{\text{amb}} < +60^{\circ}\text{C}$ Product group: B, tariff number: 8525 8900
RoughCam IPQ1715 T10-VA2.2.K1.BOR-N.N-005.N-P 	     	Network camera in a stainless steel housing. PoE, IEEE 802.3af Type2, Class 4 (max. 13.5 W, typ. 12.0 W) Minimum illumination: Color: 0.1 lx, Black/White: 0.02 lx Horizontal angle of view: 76° - 3.6° (HD, 16/9) (Motorzoom) Zoom: 21x optical Video compression: H.264, H.265, Motion JPEG Resolution: 1920 x 1080 (FullHD) to 160 x 120 Protection level: IP 66/68 (IEC / EN 60529) Ambient temperature: $-20^{\circ}\text{C} < T_{\text{amb}} < +60^{\circ}\text{C}$ Product group: B, tariff number: 8525 8900

RoughCam Series

Product / Model		Description
RoughCam IPQ1785 T10-VA2.3.K3.BOR2-N.H-005.N-P 	     	Network camera in a stainless steel housing. PoE, IEEE 802.3af Type1, Class 3 (max. 12.95 W, typ. 7.7 W) Minimum illumination: Color: 0.16 lx, Black/White: 0.03 lx Horizontal angle of view: 60° - 2.3° (HD, 16/9) (Motorzoom) Video compression: H.264 (MPEG-4 Part 10/AVC), Motion JPEG Resolution: 1920 x 1200 (WUXGA) to 160 x 90 Protection level: IP 66/68 (IEC / EN 60529) Ambient temperature: $-10^{\circ}\text{C} < T_{\text{amb}} < +60^{\circ}\text{C}$ Product group: B, tariff number: 8525 8900
RoughCam IPQ1785-W		Wash & Wipe; with control line for connection to the cam.Cleaner
RoughCam IPP1280 T10-VA0.1.K1.GER-N.N-005.N-P 	     	Modular thermal network camera: Sensor Unit in stainless steel housing. Main Unit P12 Mkl PoE, IEEE 802.3af/802.3at Type1 Class 2 (typ. 2.5 W, max. 4 W) Uncooled microbolometer, spectral range 8 μm to 14 μm (corresponds to temperature range of radiation from -66°C to 89°C) Horizontal angle of view: 35.4° Resolution: 208 x 156 Protection Level (Sensor-/Main Unit): IP66/68/IP66 (IEC / EN 60529) Ambient temperature Sensor Unit: $-30^{\circ}\text{C} < T_{\text{amb}} < +60^{\circ}\text{C}$ Ambient temperature Main Unit: $-20^{\circ}\text{C} < T_{\text{amb}} < +50^{\circ}\text{C}$ Product group: B, tariff number: 8525 8900
RoughCam		For our RoughCam series, we have the same configuration options as for our ExCam series! If you are unsure which option fits to which camera? Ask us: sales@samcon.eu
Mounting accessories...		A wide range can be found on #page_40!

The T07-Series - Flameproof Camera Enclosure Series

































Camera Housing (Ex)

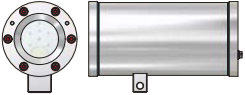











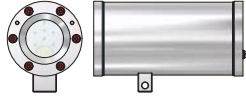

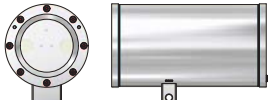
T07 Housing Series
with size comparison

The **T07 housing series** is an extremely powerful camera housing concept suitable for hazardous areas and is certified according to European regulations (ATEX) as well as international ones (IECEx) (**U-Component-Certificate**). The housings' certification comprises ATEX group I (mining) and ATEX group II (gas & dust). In accordance with the requirements of the impact and free-fall tests (DIN EN 60079: 0 2012), the housings are suitable for fix and mobile (portable) applications!

Group II (Gas & Dust)	ATEX / IECEx (U)					Group I (Mining)	ATEX / IECEx..	
Zone	0	1	2	21	22	Category	Ma	Mb
Application	✗	✓	✓	✓	✓	Application	✗	✓

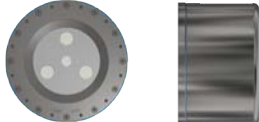
Product / Model	Description	
T07-VA0.1.K1.BOR 	    	Explosion proof camera housing in stainless steel according to Directive 2014/34/EU (ATEX) and IECEx (component certification) Dimensions (without pin): 48x48x127mm, w: 500g, V _{void} : 136cm ³ Explosion protection (gas): Ex db IIC Gb Explosion protection (dust): Ex tb IIIC Db Protection level: IP 66/68 (IEC / EN 60529) Ambient temperature: -60°C < T _{amb} < +135°C Product group: A, tariff number: 8529 9092
T07-VA0.1.K1.GER 	    	Explosion proof camera housing in stainless steel with germanium glass for thermal application according to Directive 2014/34/EU (ATEX) and IECEx (component certification) Dimensions (without pin): 48x48x127mm, w: 540g, V _{void} : 136cm ³ Explosion protection (gas): Ex db IIC Gb Explosion protection (dust): Ex tb IIIC Db Protection level: IP 66/68 (IEC / EN 60529) Ambient temperature: -30°C < T _{amb} < +135°C Product group: A, tariff number: 8529 9092
T07-VA0.4.K1.BOR 	    	Explosion proof camera housing in stainless steel according to Directive 2014/34/EU (ATEX) and IECEx (component certification) Dimensions (without pin): 48x48x172mm, w: 600g, V _{void} : 200cm ³ Explosion protection (gas): Ex db IIC Gb Explosion protection (dust): Ex tb IIIC Db Protection level: IP 66/68 (IEC / EN 60529) Ambient temperature: -60°C < T _{amb} < +135°C Product group: A, tariff number: 8529 9092
T07-VA0.4.K1.GER 	    	Explosion proof camera housing in stainless steel with germanium glass for thermal application according to Directive 2014/34/EU (ATEX) and IECEx (component certification) Dimensions (without pin): 48x48x172mm, weight: 600g Void volume: 200cm ³ Explosion protection (gas): Ex db IIC Gb Explosion protection (dust): Ex tb IIIC Db Protection level: IP 66/68 (IEC / EN 60529) Ambient temperature: GER: -30°C < T _{amb} < +135°C Product group: A, tariff number: 8529 9092
T07-VA1.2.K1.BOR 	      	Explosion proof camera housing in stainless steel according to Directive 2014/34/EU (ATEX) and IECEx (component certification) Dimensions (without pin): 79x79x157 mm, weight: 2200 g, Void volume: 480 cm ³ Explosion protection (gas): Ex d IIC Gb Explosion protection (dust): Ex tb IIIC Db IP68 Explosion protection (mining): Ex d I Mb Protection level: IP 66/68 (IEC / EN 60529) Ambient temperature: -60°C < T _{amb} < +160°C Product group: A, tariff number: 8529 9092

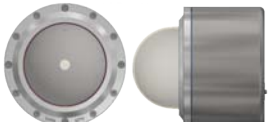
Camera Housing (Ex)

Product / Model	Description	
T07-VA2.0.K1.BOR 		Explosion proof camera housing in stainless steel according to Directive 2014/34/EU (ATEX) and IECEx (component certification) Dimensions (without pin): 113x113x161 mm, weight: 3600 g, Void volume: 1,080 cm ³ Explosion protection (gas): Ex d IIC Gb Explosion protection (dust): Ex tb IIIC Db IP68 Explosion protection (mining): Ex d I Mb Protection level: IP 66/68 (IEC / EN 60529) Ambient temperature: -60°C < T _{amb} < +160°C Product group: A, tariff number: 8529 9092
T07-VA2.1.K1.BOR 		Explosion proof camera housing in stainless steel according to Directive 2014/34/EU (ATEX) and IECEx (component certification) Dimensions (without pin): 113x113x210 mm, weight: 4200 g, Void volume: 1,520 cm ³ Explosion protection (gas): Ex d IIC Gb Explosion protection (dust): Ex tb IIIC Db IP68 Explosion protection (mining): Ex d I Mb Protection level: IP 66/68 (IEC / EN 60529) Ambient temperature: -60°C < T _{amb} < +160°C Product group: A, tariff number: 8529 9092
T07-VA2.2.K1.BOR 		Explosion proof camera housing in stainless steel according to Directive 2014/34/EU (ATEX) and IECEx (component certification) Dimensions (without pin): 113x113x261 mm, weight: 5100 g, Void volume: 1,960 cm ³ Explosion protection (gas): Ex d IIC Gb Explosion protection (dust): Ex tb IIIC Db IP68 Explosion protection (mining): Ex d I Mb Protection level: IP 66/68 (IEC / EN 60529) Ambient temperature: -60°C < T _{amb} < +160°C Product group: A, tariff number: 8529 9092
T07-VA2.3.K3.BOR2 		Explosion proof camera housing in stainless steel according to Directive 2014/34/EU (ATEX) and IECEx (component certification) Dimensions (without pin): 113x113x310 mm, weight: 5900g, Void volume: 2350 cm ³ Explosion protection (gas): Ex db IIC Gb Explosion protection (dust): Ex tb IIIC Db Explosion protection (mining): Ex db I Mb Protection level: IP 66/68 (IEC / EN 60529) Ambient temperature: -60°C < T _{amb} < +160°C Product group: A, tariff number: 8529 9092
T07-VA4.1K.BOR1 		Explosion proof camera housing in stainless steel according to Directive 2014/34/EU (ATEX) and IECEx (component certification) Dimensions (wxhxd): 216x216x145mm, weight: 13660g, Void volume: 3580cm ³ Explosion protection (gas): Ex db IIC Gb Explosion protection (dust): Ex tb IIIC Db Explosion protection (mining): Ex db I Mb Protection level: IP 66/68 (IEC / EN 60529) Ambient temperature: -60°C < T _{amb} < +160°C Product group: A, tariff number: 8529 9092
T07-VA4.1K.PS1 		Explosion proof camera housing in stainless steel with thermoplastic dome acc. to Directive 2014/34/EU (ATEX) & IECEx (component certification) Dimensions (wxhxd): 216x216x236mm, weight: 11300g, Void volume: 4880cm ³ Explosion protection (gas): Ex db IIC Gb Explosion protection (dust): Ex tb IIIC Db Protection level: IP 66/68 (IEC / EN 60529) Ambient temperature: -50°C < T _{amb} < +135°C Product group: A, tariff number: 8529 9092

Camera Housing (Ex)

Product / Model	Description
T11	All housings are also available as T11 camera-housings for the use in safe areas. All housings meet the same high quality standards as our ExCam housings and are therefore perfect for even the roughest industrial conditions. The stainless steel housing in combination with quality glass and high-end sealings make them resistant to nearly all media; withstanding even the highest mechanical demands.

All our housings are waterproof, dustproof and protected against strong water jets. They also passed the steam jet test according to ISO 20653:2013-0 (protection class IPx9K). However, we only label our devices with protection class IP66/IP68. The reason for this is that only the enclosures without cable entry are tested in the protection class test, however, the cable entry is the weakest link in the protection system. We therefore recommend not aiming at the cable gland when cleaning with a high-pressure cleaner/steam jet. You can find more detailed information on the IP test in the [test report](#)

You can't find a suitable ex-proof camera or you want a certain camera modul, upon request we build your desired ExCam (**BTO**). Please ask us and visit our homepage www.samcon.eu/en/products/bto/

Usable Dimensions

VAo.1.K1.BOR/GER

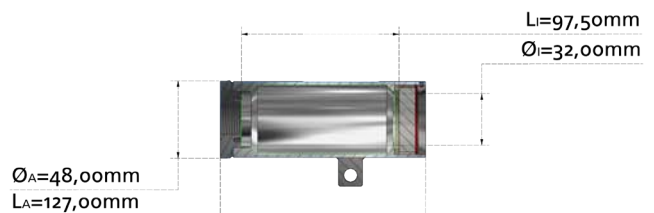

VAo.4.K1.BOR/GER

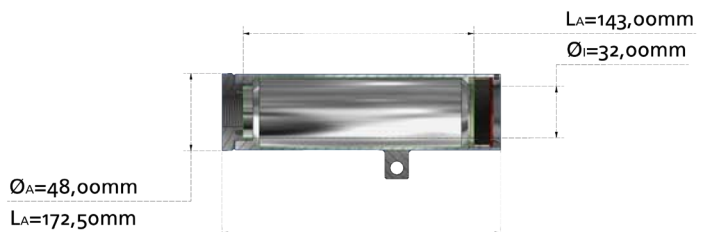

VA1.2.K1.BOR

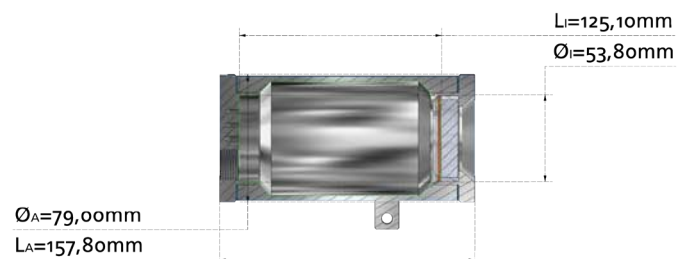
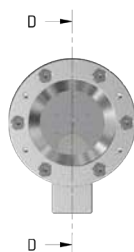

VA2.o.K1.BOR

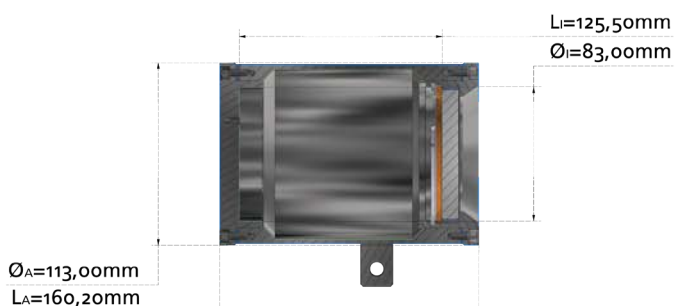

Usable Dimensions

VA2.1.K1.BOR

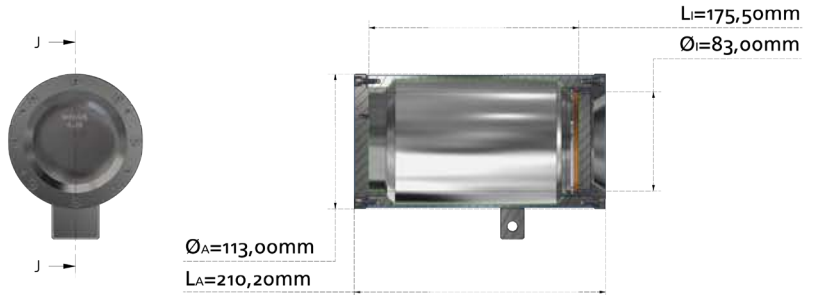

VA2.2.K1.BOR

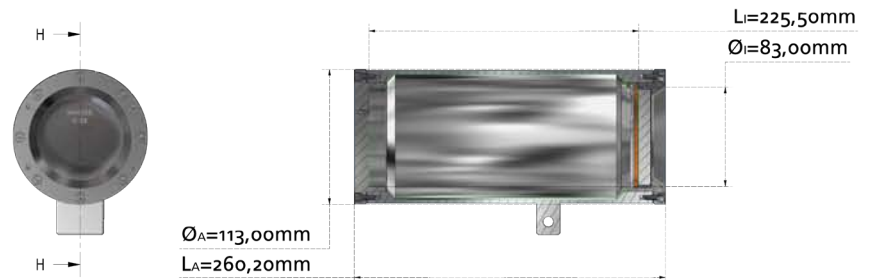

VA2.3.K3.BORz

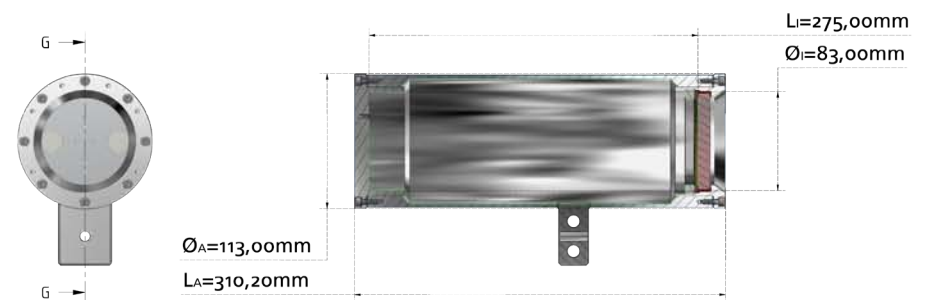
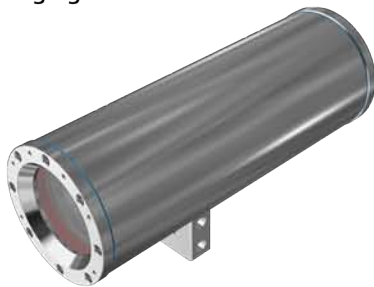

VA4.1K.BOR1

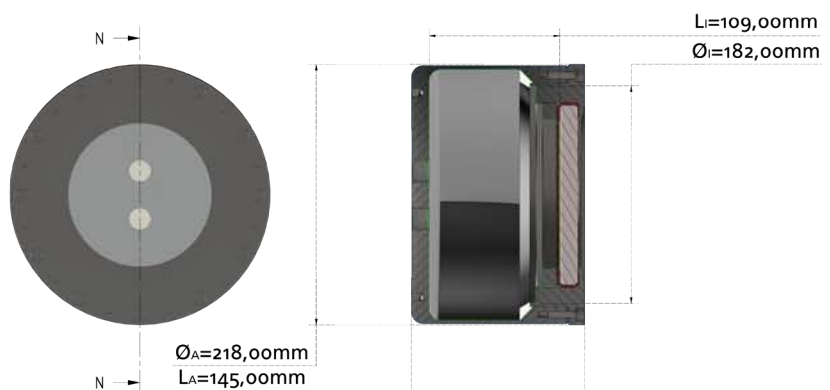
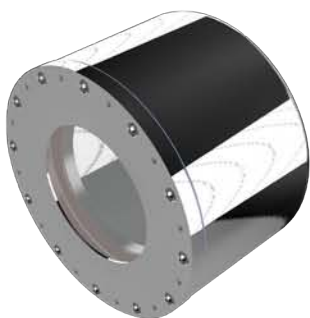

VA4.1K.PS1

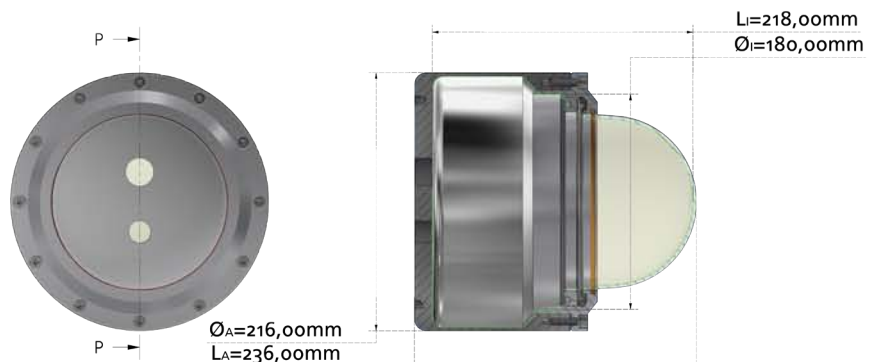

liteServer Ex.micro - Ultracompact Luminaire for Process Illumination





liteServer Ex.micro
in stainless steel housing













liteServer Ex.micro

The **liteServer Ex.micro** is approved in accordance with **2014/34/EU (ATEX) & IECEx**. Process and object lighting are obligatory in explosion risk zones and hazardous areas. The right combination of lighting equipment and the usage of fast camera lenses is essential to get crisp and sharp images. The following lighting systems are the perfect match for the ExCam series; using the same pressure-proof housings. Almost all lighting systems are available for non-explosion risk zones also.











Group II (Gas & Dust)	ATEX / IECEx					Group I (Mining)	ATEX / IECEx	
Zone	0	1	2	21	22	Category	Ma	Mb
Application	✗	✓	✓	✓	✓	Application	✗	✓

Product / Model	Description	
liteServer Ex.micro.24.WL90 T20-VA0.1.K1.BOR-L.N-005.1-K 		Luminaire for hazardous areas acc. to GL 2014/34/EU (ATEX) and IECEx. P _{max} : 12.9W@24VDC Luminous flux: 1930lm; 12.5W COB-LED Beam angle: 90° Color temperature: 5000K (neutral white) Explosion protection (gas): Ex II 2G Ex db IIC T5 Gb Explosion protection (dust): Ex II 2D Ex tb IIIC T95°C Db Protection level: IP 66/68 (IEC / EN 60529) Ambient temperature: -30°C < T _{amb} < +50°C www.samcon.eu/en/products/luminaires/liteserver-exmicro/ Included: 5 m connection cable 3G x 0.75 mm ² Product group: B, tariff number: 9405 4910
liteServer Ex.micro.24.IR90 T20-VA0.1.K1.BOR-L.N-005.1-K 		Infrared luminaire for hazardous areas acc. to GL 2014/34/EU (ATEX) and IECEx. P _{max} : 12.7W@24VDC Radiant intensity: 4120mW; 12W COB-LED Beam angle: 90° Infrared centroid wavelength: 850nm Explosion protection (gas): Ex II 2G Ex db IIC T5 Gb Explosion protection (dust): Ex II 2D Ex tb IIIC T95°C Db Protection level: IP 66/68 (IEC / EN 60529) Ambient temperature: -30°C < T _{amb} < +50°C www.samcon.eu/en/products/luminaires/liteserver-exmicro/ Included: 5 m connection cable 3G x 0.75 mm ² Product group: B, tariff number: 9405 4910
Option Mining		Explosion protection (mining): Ex I M2 Ex db I Mb Included accessories: 5 meter connection cable 3G x 0.75 mm ² , special gland
Mounting accessories...		A wide range can be found on #page_40!





Process Illumination and Illumination for Small Spaces

Product / Model		Description
ChemLux Power d LED-S K 	  	Lighting for explosion risk zones 230-240V AC, 7W, T _{amb} : -20°C to +40°C Explosion protection (gas): Ex II 2G Ex d IIC T6 Gb Explosion protection (dust): Ex II 2D Ex tb IIIC T80°C Db IP67 Protection level: IP 67 (IEC / EN 60529) Includes 5 m cable 3G x 1.5 mm ² Product group: C, tariff number: 9405 4910
EdelEx 50 dH K1 (T3) 	  	Lighting for explosion risk zones 24V AC/DC, 50W, T _{amb} : -20°C to +40°C Explosion protection (gas): Ex II 2G Ex d IIC T3 Gb Explosion protection (dust): Ex II 2D Ex tb IIIC T195°C Db IP67 Protection level: IP 67 (IEC / EN 60529) Includes 5 m cable 3G x 1.5 mm ² Product group: C, tariff number: 9405 4910
EdelEx d PowerLED K1 	  	Lighting for explosion risk zones 24V AC/DC or 230-240V AC, 7W, T _{amb} : -20°C to +40°C Explosion protection (gas): Ex II 2G Ex d IIC T6 Gb Explosion protection (dust): Ex II 2D Ex tb IIIC T80°C Protection level: IP 65/67 (IEC / EN 60529) Includes 5 m cable 3G x 1.5 mm ² Product group: C, tariff number: 9405 4910

Room Illumination (White Light)

Product / Model		Description
SPX-FL24-W-8030 	   	LED White Light Illuminator 60W (80° x 30°) Angle: 80° x 30°, Operating voltage: 110-254V AC Power: 60 W Luminous flux 4000 lm, Dimensions: 291x247x150 mm Explosion protection (gas): Ex em IIC T4 Gb Explosion protection (dust): Ex tb IIIC T82°C Db T _{amb} : -50°C to +55°C, Protection level: IP66 (IEC / EN 60529) 24 ultra-durable LED, CoolExtrude™ Temperature Management More angles, light-range and temperature classes on request. Product group: C, tariff number: 9405 4910
SPX-FL48-W-8030 	   	LED White Light Illuminator 120W (80° x 30°) Angle: 80° x 30°, Operating voltage: 110-254V AC Power: 120W, luminous flux 8000 lm, Dimensions: 291x438x151 mm Explosion protection (gas): Ex em IIC T4 Gb Explosion protection (dust): Ex tb IIIC T82°C Db T _{amb} : -50°C to +55°C, Protection level: IP66 (IEC / EN 60529) 48 ultra-durable LED, CoolExtrude™ Temperature Management More angles, light-range and temperature classes on request. Product group: C, tariff number: 9405 4910

Room Illumination (Infrared)

Product / Model	Description	
SPX-FL24-I-8030 		LED Infrared Illuminator 60W (80° x 30°) Viewing angle: 80° x 30°, Illumination range: 58 m Operating voltage: 110-254V AC Power: 60W, 850 nm wavelength, dimensions: 291x247x150 mm Explosion protection (gas): Ex em IIC T4 Gb Explosion protection (dust): Ex tb IIIC T82°C Db T _{amb} : -50°C to + 55°C, Protection level: IP66 (IEC / EN 60529) 24 ultra-durable LED, CoolExtrude™ Temperature Management More angles, light-range and temperature classes on request. Product group: C, tariff number: 9405 4910
SPX-FL48-I-8030 		LED Infrared Illuminator 120W (80° x 30°) Viewing angle: 80° x 30°, Illumination range: 80 m Operating voltage: 110-254V AC Power: 120W, wavelength 850 nm, dimensions: 291x438x151 mm Explosion protection (gas): Ex em IIC T4 Gb Explosion protection (dust): Ex tb IIIC T82°C Db T _{amb} : -50°C to + 55°C, Protection level: IP66 (IEC / EN 60529) 48 ultra-durable LED, CoolExtrude™ Temperature Management More angles, light-range and temperature classes on request. Product Group: C, tariff number: 9405 4910

The liteServer Rough.micro - Ultracompact Luminaire for Process Illumination





liteServer Rough.micro
in stainless steel housing

liteServer Rough.micro

The **liteServer Rough.micro** is especially suitable for use under the harshest conditions. It is the perfect complement to our cameras in low-light areas. It has a long-lasting, energy-efficient LED, either in visible white or infrared light. Since the combination of illuminance and camera sensitivity is so important, the following process illumination is optimally tailored to the RoughCam series!

Group II (Gas & Dust)	-				
Zone	0	1	2	21	22
Application	✗	✗	✗	✗	✗

Group I (Mining)	-	
Category	Ma	Mb
Application	✗	✗

Product / Model	Description	
liteServer Rough.micro.24.WL90 T21-VA0.1.K1.BOR-L.N-005.1-K 	IP66 IP68 -30°C +50°C	Luminaire in stainless steel housing. (IP66/68) P_{max} : 12.9W@24VDC Luminous flux: 1930lm; 12.5W COB-LED Beam angle: 90° Color temperature: 5000K (neutral white) Ambient temperature: $-30^{\circ}\text{C} < T_{amb} < +50^{\circ}\text{C}$ www.samcon.eu/en/products/luminaires/liteserver-roughmicro/ Product group: B, tariff number: 9405 4910
liteServer Rough.micro.24.IR90 T21-VA0.1.K1.BOR-L.N-005.1-K 	IP66 IP68 -30°C +50°C	Infrared luminaire in stainless steel housing. (IP66/68) P_{max} : 12.7W@24VDC Radiant intensity: 4120mW; 12W COB-LED Beam angle: 90° Infrared centroid wavelength: 850nm Ambient temperature: $-30^{\circ}\text{C} < T_{amb} < +50^{\circ}\text{C}$ Product group: B, tariff number: 9405 4910
Mounting accessories...		A wide range can be found on #page_40!



Mounting Accessories

All accessories have been thoroughly tested with regard to their use in industrial zones, reflecting the highest quality standards. Accessories for explosion risk zones are in accordance with the current norms; DIN EN 60079-0,-14, Directive 2014/34/EU, as well as the norms for the applicable explosion protection.

Mounting Systems for the ExCam Series T08-VA... and the RoughCam Series T10-VA...

Product / Model	Description
Wall Mounting Bracket WMB-VA0.x/VA1.x 	Wall bracket short (stainless steel) Manual pan angle: 360°, manual tilt angle: 90° Includes hinge and mounting accessories in accordance with housing identity code: VA0.x, VA1.x Product group: A, tariff number: 8529 9092
Wall Mounting Bracket WMB-VA2.0-VA2.2 	Wall bracket long (stainless steel) Manual pan angle: 360°, manual tilt angle: 90° Includes hinge and mounting accessories in accordance with housing identity code: VA2.0, VA2.1 and VA2.2 Product group: A, tariff number: 8529 9092
Wall Mounting Bracket WMB-VA2.3 	Wall bracket for cameras of the series T08-VA2.3 (stainless steel) Manual pan angle: 360°, manual tilt angle: 90° Load bearing: 50 kg Includes hinge and mounting accessories Product group: A, tariff number: 8529 9092
Clamp fastening KLEMM-WMB-VA2.3 	For mounting the wall mount bracket WMB-VA2.3 to an I beam (DIN 1025) Suitable for IPBI 250 to IPBI 280 Material: 1.4404/1.0038 Point load: 57 kg Product group: A, tariff number: 8529 9092
Twin-Adapter WMB-VAx.x-TA-...-... 	Twin Adapter (stainless steel) Manual pan angle: 360°, manual tilt angle: 90° Includes hinge and mounting accessories for 2 devices (without WMB) WMB-VA1.x-TA for camera/luminaire VA1.x or WMB-VA2.x for camera/luminaire VA2.0/VA2.1/VA2.2 Product group: A, tariff number: 8529 9092
SuperClamp - Mounting Adapter SCMA-VA0.x/VA1.x 	Super Clamp mounting adapter Screwless rapid installation of ExCams with the model keys T08-VA0.x/VA1.x to round or square profiles and pipe bridges. For diameters of 13 mm to 55 mm Point load: 15 kg; Includes hinge and mounting accessories Product group: A, tariff number: 8529 9092
SuperClamp - Mounting Adapter SCMA-VA2.0-VA2.2 	Super Clamp mounting adapter Screwless rapid installation of ExCams with the model keys T08-VA2.0/VA2.1/VA2.2 to round or square profiles and pipe bridges. For diameters of 13 mm to 55 mm Point load: 15 kg; Includes hinge and mounting accessories Product group: A, tariff number: 8529 9092
Pole Mounting Bracket PMB-VA0.x/VA1.x/VA2.x 	Pole Mounting Bracket Compatible with all „WMB“ wall brackets of the ExCam series with the model keys T08-VA0.x, T08-VA1.x and T08-VA2.x For diameters of 50 mm to 105 mm Point load: 50 kg Product group: A, tariff number: 8529 9092
Hinge attachment SCH-VA0.x/VA1.x 	Hinge attachment Easy mounting on round sight glasses. In accordance with DIN 28120/28121 (or similar) Includes mounting accessories for housing: VA0.x, VA1.x Product group: A, tariff number: 8529 9092



Mounting Systems for the ExCam Series T08-VA... and the RoughCam Series T10-VA...

Product / Model	Description
Hinge attachment SCH-VA2.0-VA2.2 	Hinge attachment Easy mounting on round sight glasses. In accordance with DIN 28120/28121 (or similar) Includes mounting accessories for housing: VA2.0, VA2.1, VA2.2 Product group: A, tariff number: 8529 9092
Hinge attachment SCH-VA2.3 	Hinge attachment Easy mounting on round sight glasses. In accordance with DIN 28120/28121 (or similar) Includes mounting accessories for housing: VA2.3 Product group: A, tariff number: 8529 9092
Thermo Isolator THERM-VA 	Thermo isolator for flanging the T03-VA... and T08-VA1.x...series onto hot sight glasses or to avoid incidences of extraneous light. Temperature range: -45° C to +100° C Durability: Weatherproof, ozone proof, non-ageing, acid resistant, alkali resistant Characteristics: extremely flame resistant, abrasion and impact resistant. Electrically puncture-proof Product group: A, tariff number: 8529 9092

Weather Protection for the ExCam Series T08-VA... and the RoughCam Series T10-VA..

Product / Model	Description
Weather Protection Roof WPR-VA0.1 	Hood (stainless steel) Includes hinge and mounting accessories for housing: WPR-VA0.1: for T08-VA0.1 Product group: A, tariff number: 8529 9092
Weather Protection Roof WPR-VA1.x 	Hood (stainless steel) Includes hinge and mounting accessories for housing: WPR-VA1.1: for T08-VA1.1 WPR-VA1.2: for T08-VA1.2 Product group: A, tariff number: 8529 9092
Weather Protection Roof WPR-VA2.0 	Hood (stainless steel) Includes hinge and mounting accessories for housing: WPR-VA2.0: for T08-VA2.0 Product group: A, tariff number: 8529 9092
Weather Protection Roof WPR-VA2.1 	Hood (stainless steel) The weather protection hoods for the ExCam T08 series dispose of mounting holes with a spacing of 5 mm in order to allow adjusting the hood's position to perfectly meet the selected angle of view. Includes hinge and mounting accessories for housing: WPR-VA2.1: for T08-VA2.1 Product group: A, tariff number: 8529 9092
Weather Protection Roof WPR-VA2.2 	Hood (stainless steel) The weather protection hoods for the ExCam T08 series dispose of mounting holes with a spacing of 5 mm in order to allow adjusting the hood's position to perfectly meet the selected angle of view. Includes hinge and mounting accessories for housing: WPR-VA2.2: for T08-VA2.2 Product group: A, tariff number: 8529 9092
Weather Protection Roof WPR-VA2.3 	Hood (stainless steel) The weather protection hoods for the ExCam T08 series dispose of mounting holes with a spacing of 5 mm in order to allow adjusting the hood's position to perfectly meet the selected angle of view. Includes hinge and mounting accessories for housing: WPR-VA2.3: for T08-VA2.3 Product group: A, tariff number: 8529 9092





















Mounting Accessories for the ExCam Series To8-TNXCD and To8-VA4.x

Product / Model	Description
Wall bracket WMB-TNXCD/VA4.x... 	Wall bracket for cameras of the T08-TNXCD and T08-VA4.x Series (stainless steel) The wall mount bracket has a two-part design with the main part consisting of a massive stainless steel welding construction. A protective hood for the wall mount bracket is also included in the delivery scope in order to protect the cable glands according to 60079-14 and to prevent that they are exposed to direct splash water. Load rating: 50 kg Dimensions: 460 x 220 140 mm Product group: A, tariff number: 8529 9092
Pole Mounting Bracket PMB-TNXCD/VA4.x 	Pole mount adapter PMB-TNXCD/VA4.x Pole adapter for TNXCD/VA4.x wall brackets Material: Stainless steel 1.4404 Suitable for pole diameters of 100 mm and 150 mm Load rating: 50 kg Product group: A, tariff number: 8529 9092
Ceiling Mount Adapter CMB-TNXCD/VA4.x 	Mounting attachment for cameras of the T08-TNXCD / VA4.x series for attachment to ceilings or for vertical mounting Material: Stainless steel 1.4404 Load capacity: 50 kg Product group: A, tariff number: 8529 9092

Installation Equipment

All accessories have been thoroughly tested with regard to their use in industrial zones, reflecting the highest quality standards. Accessories for explosion risk zones are in accordance with the current norms; DIN EN 60079-0,-14, regulation 2014/34/EU as well as the norms for the applicable explosion protection.

Terminal Boxes in Ex-e

Product / Model		Description
ExTB-2 T12-M20-BP-M20 	     	Terminal box for analog and digital ExCam systems Ex.-protection (gas): Ex II 2 G Ex eb IIC T5 Gb Ex.-protection (dust): Ex II 2 D Ex tb IIIC T95°C Db Material: Polyester resin, dimensions: 145 x 145 x 71 mm Protection level: IP 66, Ambient temperature limit: -60°C to +55°C Max. power supply: 690V, max. diameter: 2.5 mm ² 10 pcs. terminal clamp UT 2.5, Marking: 1-10, 3 pcs. terminal clamp UT 2.5 PE 2 pcs. M20 cable gland for non-armoured cables Cable cross-section: 7 ... 13 mm ² Product group: C, tariff number: 8536 9010
ExTB-3 T12-M20-M20-M20 	     	Terminal box for analog and digital ExCam systems Ex.-protection (gas): Ex II 2 G Ex eb IIC T5 Gb Ex.-protection (dust): Ex II 2 D Ex tb IIIC T95°C Db Material: Polyester resin, dimensions: 145 x 145 x 71 mm Protection level: IP 66, Ambient temperature limit: -60°C to +55°C Max. power supply: 690V, max. diameter: 2.5 mm ² 10 pcs. terminal clamp UT 2.5 (1-10), 3 pcs. terminal clamp UT 2.5 PE 3 pcs. M20 cable gland for non-armoured cables Cable cross-section: 7 ... 13 mm ² Product group: C, tariff number: 8536 9010
ExTB-4 T12-M20-M20-M20-M20 	     	Terminal box for analog as well as digital ExCam systems Ex.-protection (gas): Ex II 2 G Ex eb IIC T5 Gb Ex.-protection (dust): Ex II 2 D Ex tb IIIC T95°C Db Material: polyester resin, Dimensions: 145 x 145 x 71 mm Protection level: IP 66, Ambient temperature limit: -60°C to +55°C Maximum power supply: 690V, Maximum diameter: 2.5 mm ² 10 pcs. terminal clamp UT 2.5, Marking: 1-10, 3 pcs. terminal clamp UT 2.5 PE 4 pcs. M20 cable gland for non-armoured cables Cable cross-section: 7 ... 13 mm ² Product group: C, tariff number: 8536 9010
Ex-e Terminal Box (BTO) ExTB-(BTO)		We have a large selection of junction boxes in Ex-e or Ex-d execution. Different materials, sizes and cable entries can be freely combined. Please ask us!

The smart.Cleaner - IP-Washing Water Supply Unit for up to 4 Cameras



smart.Cleaner
in a stainless steel housing

smart.Cleaner

The **smart.Cleaner** guarantees optimum view! Clear sight thanks to efficient cleansing! With the smart.Cleaner we provide a compact, powerful IP-washing-water-supply-unit. This cleaning unit has been developed especially for use in hazardous areas. Despite its small size up to 4 ex-cameras can be connected. The washing system is controlled via IP. The smart.Cleaner possesses an I/O-modul. The cleaning fluid can be controlled directly via the camera or via the browser. The 4 valves are switchable very quickly and are extremely sturdy.

Group II (Gas & Dust)	ATEX / IECEx/ EAC-Ex				
Zone	0	1	2	21	22
Application	✗	✓	✓	✓	✓

Group I (mining)	-	
Category	Ma	Mb
Application	✗	✗



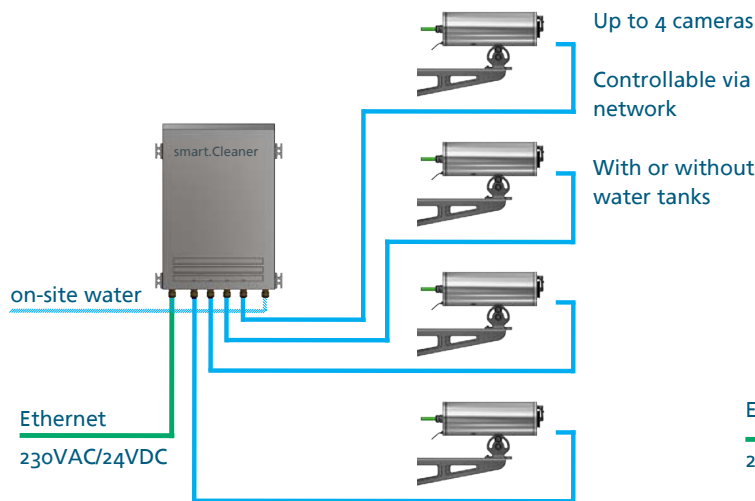

Hazardous Area

Setup with on-site-cleaning water

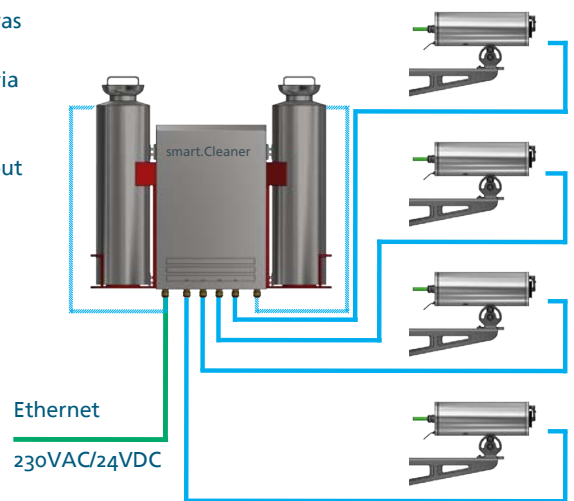



Setup with integrated 20l pressure tank



Product / Model	Description
smart.Cleaner T05-4-24-0DR-N.N-005.A-P 	    Network controlled washer fluid supply unit according to RL 2014/34/EU (ATEX), IECEx Power supply: 24VDC Typical power consumption: 37W Explosion protection (gas): Ex II 2G Ex IIC T4 Gb Explosion protection (dust): Ex II 2D Ex IIIC T130°C Db Protection level: IP 66 (IEC / EN 60529) Ambient temperature: $-10^{\circ}\text{C} < T_{\text{amb}} < +45^{\circ}\text{C}$ Maximum water pressure: 3.5bar Coupling sockets water connection NW 7.2 www.samcon.eu/en/products/equipment/smart-cleaner/ www.samcon.eu, product group: B, tariff number: 8424 8970
smart.Cleaner T05-4-24-0DR-N.N-005.A-T	Network controlled washer fluid supply unit 24VDC with terminal box termination: Included accessories: 5 m digital cable pre-mounted and pre-wired to an ex-e terminal box (see Ex-TB3) www.samcon.eu, product group: B, tariff number: 8424 8970

Wash and Wipe Equipment

Product / Model		Description
smart.Cleaner T05-4-24- <u>2DR</u> -N.N-005.A-P 		Network controlled washer fluid supply unit 24VDC with 2 pressure vessels: Maximum pressure of pressure vessel: 3.5bar (compressed air supply or integrated hand tank pump) Maximum filling quantity per tank: 10 l www.samcon.eu, product group: B, tariff number: 8424 8970
smart.Cleaner T05-4-24- <u>2DR</u> -N.N-005.A- <u>T</u>		Network controlled washer fluid supply unit 24VDC with 2 pressure vessels and digital cable pre-mounted and pre-wired to an ex-e terminal box (see Ex-TB3) www.samcon.eu, product group: B, tariff number: 8424 8970
smart.Cleaner T05-4- <u>230</u> -XDR-X.N-005.A-X		Network controlled washer fluid supply unit according to RL 2014/34/EU (ATEX), IECEx Power supply: 230VAC Typical power consumption: 45W ... upon request www.samcon.eu, product group: B, tariff number: 8424 8970
smart.Cleaner T05-4-230-XDR- <u>LL</u> .N-005.A-X		Network controlled washer fluid supply unit according to RL 2014/34/EU (ATEX), IECEx for low temperatures Ambient temperature: $-30^{\circ}\text{C} < T_{\text{amb}} < +45^{\circ}\text{C}$... upon request www.samcon.eu, product group: B, tariff number: 8424 8970
Hose packages...		...upon request

The cam.Cleaner - Washing Fluid Supply Unit Single Port



cam.Cleaner

cam.Cleaner

The **cam.Cleaner** helps to clean your ex-camera! With the cam.Cleaner we provide a compact and powerful washing fluid supply unit. This cleaning unit has been developed especially for use in hazardous areas. One ex-camera could be connected. Together with selected cameras (ExCam ... -W) the cam.Cleaner could be controlled directly via camera, via Browser or Video Management System (VAPIX). The valve is switchable very quickly and it is extremely sturdy.

Group II (Gas & Dust)	ATEX / IECEx/ EAC-Ex					Group I (mining)	-	
Zone	0	1	2	21	22	Category	Ma	Mb
Application	✗	✓	✓	✓	✓	Application	✗	✗





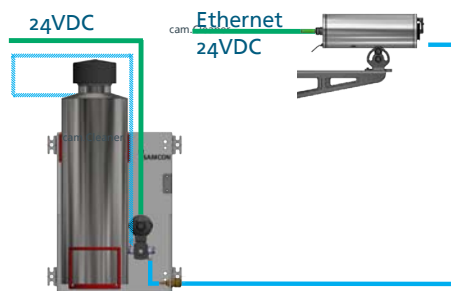

Hazardous Area

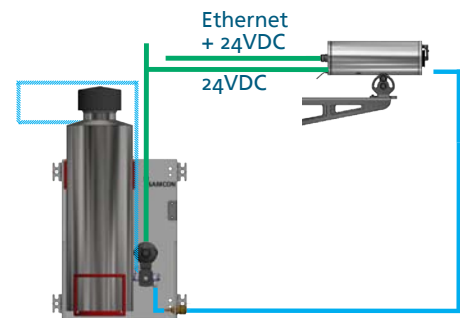
Single Port
not controllable



Together with selected cameras (ExCam ...-W)
fluid supply controllable via camera



Product / Model	Description	
cam.Cleaner T05-1-24-1DR-N.N 	   	Washer fluid supply unit Single Port according to RL 2014/34/EU (ATEX), IECEx Power supply: 24VDC Typical power consumption: 9W Explosion protection (gas): Ex II 2G Ex eb mb IIC T4 Gb Explosion protection (dust): Ex II 2D Ex mb tb IIIC T130°C Db Protection level: IP 66 (IEC / EN 60529) Ambient temperature: $-10^{\circ}\text{C} < T_{\text{amb}} < +55^{\circ}\text{C}$ Maximum water pressure: 5bar Coupling sockets water connection NW 7.2 www.samcon.eu/en/products/equipment/cam-cleaner/ www.samcon.eu, product group: B, tariff number: 8424 8970
cam.Cleaner T05-1-24-1DR-LL.N 		Network controlled washer fluid supply unit 24VDC with valve for low temperatures Ambient temperature: $-30^{\circ}\text{C} < T_{\text{amb}} < +55^{\circ}\text{C}$ www.samcon.eu, product group: B, tariff number: 8424 8970

The air.Blade - Pneumatic Cleaning System, better sight in dusty environments







air.Blade
mounted on camera

air.Blade

The **air.Blade** improves visibility in dusty environments thanks to efficient pneumatic cleaning! The air.Blade is a simple but effective lens-cleaning system for our ExCam Series. It can be used in gas-explosion risk zones. The purging device can be used to a limited extent in areas with combustible dust.

Group II (gas)	ATEX / IECEx / EAC-Ex					Group I (mining)	-	
Zone	0	1	2	21	22	Category	Ma	Mb
Application	✗	✓	✓	✓	✓	Application	✗	✗

Product / Model	Description	
air.Blade T95-VA1.x 		Pneumatic cleaning system for cameras of the T08/T10-VA1.x Series Pressure supply: 16bar max. (temporary cleaning); 2-3bar average (continuous cleaning) Compressed air supply: 8mm Ambient temperature: -30°C < T _{amb} < +150°C www.samcon.eu/en/products/equipment/air-blade/ Product group: B, tariff number: 8525 8019
air.Blade T95-VA2.x 		Pneumatic cleaning system for cameras of the T08/T10-VA2.x Series Pressure supply: 16bar max. (temporary cleaning); 2-3bar average (continuous cleaning) Compressed air supply: 8mm Ambient temperature: -30°C < T _{amb} < +150°C Product group: B, tariff number: 8525 8019
air.Blade T95-VA4.x.BOR 		Pneumatic cleaning system for cameras of the T08/T10-VA4.x.BOR Series Pressure supply: 16bar max. (temporary cleaning); 2-3bar average (continuous cleaning) Compressed air supply: 8mm Protection level: IP 68 (IEC / EN 60529) Ambient temperature: -30°C < T _{amb} < +150°C Product group: B, tariff number: 8525 8019

* Caution is required in areas with combustible dusts: The zone can change when compressed air is introduced into areas at risk of dust explosion. Please refer to our topic [brochure DUST potentially explosive areas](#). Do you have questions? Get in touch with our [sales team](#).

The water.Blade - Hydraulic Cleaning System









water.Blade
 mounted on camera

water.Blade







The **water.Blade** improves visibility thanks to efficient hydraulic cleaning!
 The water.Blade is a simple but effective lens-cleaning system for our ExCam Series and the RoughCam Series. It can be used as well in explosion risk zones as in industrial environments.

Group II (gas)	ATEX / IECEx / EAC-Ex					Group I (mining)	-	
Zone	0	1	2	21	22	Category	Ma	Mb
Application	✗	✓	✓	✓	✓	Application	✗	✗

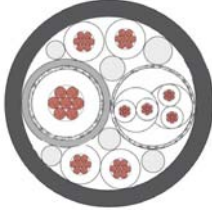
Product / Model	Description	
water.Blade T95-VA1.x 		Hydraulic cleaning system for cameras of the T08-VA1.x Series Pressure: max. 5 bar Volume flow: ≥ 5 l/min Water connection: hose nozzle 8x5,7 mm Ambient temperature: $-30^{\circ}\text{C} < T_{\text{amb}} < +150^{\circ}\text{C}$ www.samcon.eu/en/products/equipment/water-blade/ Product group: B, tariff number: 8525 8019
water.Blade T95-VA2.x 		Hydraulic cleaning system for cameras of the T08-VA2.x Series Pressure: max. 5 bar Volume flow: ≥ 5 l/min Water connection: hose nozzle 8x5,7 mm Ambient temperature: $-30^{\circ}\text{C} < T_{\text{amb}} < +150^{\circ}\text{C}$ Product group: B, tariff number: 8525 8019
water.Blade T95-VA4.x.BOR 		Hydraulic cleaning system for cameras of the T08-VA4.x.BOR Series Pressure: max. 5 bar Volume flow: ≥ 5 l/min Water connection: hose nozzle 8x5,7 mm Ambient temperature: $-30^{\circ}\text{C} < T_{\text{amb}} < +150^{\circ}\text{C}$ Product group: B, tariff number: 8525 8019

System Cables for Analog Cameras (CVBS)

Unarmoured Cables











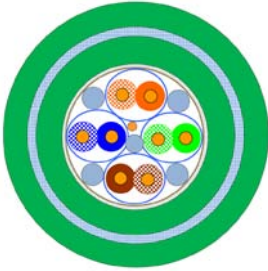







Product / Model		Description
SKA02 	    	System Cable Analog No. 02 Special cable in accordance to EN 60079-14 Outer diameter: 9.4 mm, bending radius: min. 150 mm Video: 1x75 OHM Coax AWG 24, Cu shielded Data (physic.): 2x2x0.25 mm ² closed Cu shielded Data (protocol): RS232, RS422, RS485 full duplex Power supply heating: 2x0.75 mm ² Product group: A, tariff number: 8544 4993
		...more cables upon request

System Cables for TCP/IP Network Cameras

Unarmoured Cables

Product / Model		Description
SKD01-T (non Ex) 		System Cable Digital No.01 - T Special cable for use in arctic temperatures (-60°C) Outer diameter: $\varnothing 9.1 \pm 0.2$ mm Maximum bending radius: 10 x diameter during installation Material outer jacket: PUR - flame retardant according to IEC 60322-1-2 1KW flame Construction: 4 x 2 x AWG22/1 shielded Excellent for the wiring of PoE cameras. Product group A, tariff number: 8544 4991
SKD02-T 		System Cable Digital No.02 - T Special cable for hazardous areas in accordance with EN 60079-14 Outer diameter: $\varnothing 8.9 \pm 0.3$ mm Maximum bending radius: 10 x diameter during installation Material outer jacket: PUR - flame retardant according to IEC 60322-1-2 1KW flame Construction: 4 x 2 x AWG23/1 shielded Excellent for the wiring of PoE cameras. Product group A, tariff number: 8544 4991
SKDP03-T 		System Cable Digital No.03 - T Special cable for hazardous areas in accordance with DIN EN 60079-14 for use in arctic temperatures (-60°C) Outer diameter: $\varnothing 12.4 \pm 0.3$ mm Maximum bending radius: 8 x diameter during installation Material outer jacket: PUR – flame retardant according to IEC 60322-1-2 1KW flame Construction: 4 x 2 x AWG23/1 shielded GN J/W 3G1.5 Excellent for the wiring of PoE-cameras or cameras with classic power supply. Product group A, tariff number: 8544 4993
SKD04-T.flex 		System Cable Digital No.04 - T.flexible Special cable for hazardous areas in accordance with DIN EN 60079-14 for use in arctic temperatures (-60°C) Outer diameter: $\varnothing 8.7 \pm 0.3$ mm Maximum bending radius: 8 x diameter during installation Material outer jacket: PUR – flame retardant according to IEC 60322-1-2 1KW flame Construction: 4 x 2 x AWG24/7 shielded GN J/W 3G1.5 Excellent for the wiring of PoE-cameras. Highly flexible and suitable for drag chain applications. Product group A, tariff number: 8544 4993
SKD05-HT 		System Cabel Digital N0.05 - HT Special l cable for hazardous areas in accordance with DIN EN 60079-14 for high-temperatur applications (+150°C) Outer diameter: $\varnothing 6.6 \pm 0.2$ mm Maximum bending radius: 8 x diameter during installation Material outer jacket: FEP – flame retardant according to IEC 60322-1-2 1KW flame Construction: 4 x 2 x AWG26/7 Excellent for the wiring of PoE-cameras. Suitable for high-temperature applications. Product group A, tariff number: 8544 4993

Armoured Cables

Product / Model		Description
ASKD02-T 	       	Armoured System Cable Digital No.02 - T Special cable for hazardous areas in accordance with EN 60079-14 for use in arctic temperatures (-60°C) Outer diameter: $\varnothing 12.0 \pm 0.4$ mm Maximum bending radius: 20 x diameter during installation Material outer jacket: PUR - flame retardant according to IEC 60322-1-2 1KW flame Construction: 4 x 2 x AWG23/1 shielded Excellent for the wiring of PoE cameras. Product group A, tariff number: 8544 4991
ASKDP03-T 	        	Armoured System Cable Digital Power No.03 - T Special cable for hazardous areas in accordance with EN 60079-14 for use in arctic temperatures (-60°C) Outer diameter: $\varnothing 15.5 \pm 0.6$ mm Maximum bending radius: 10 x diameter during installation Material outer jacket: PUR - flame retardant according to IEC 60322-1-2 1KW flame Construction: 4 x 2 x AWG23/1 shielded GN J/W 3G1.5 Excellent for the wiring of PoE cameras or cameras with classic power supply. Product group A, tariff number: 8544 4993
		...more cables upon request

Hazardous Areas Characteristics:



The cable meets the requirements for cables in hazardous areas in accordance to IEC/EN 60079-14 Chapter 9.3.



The cable meets the requirements for cables in hazardous areas to avoid inter-zone gas-transfer in accordance to IEC/EN 60079-14 Appendix E.

Environmental Characteristics:



The cable is tested at -60°C at fixed installation. Refer to the datasheet for temperatures regarding installation and flexible use.



The cable is tested at +80°C at fixed installation. Refer to the datasheet for temperatures regarding installation and flexible use.



The cable is sunlight resistant in accordance with UL 2556 Sec. 4.2.8.5 (720h).



The cable is flame retardant in accordance with IEC 60332-1-2.



The cable is oil resistant in accordance with IEC 60811-2-1 (IRM 902, 4h at70°C).



The cable is mud resistant in accordance with NEK 606.



The cable is suitable for drag chain use: 1 million bending cycles, bending radius 20 x D, at a speed of 4 m/s, acceleration 4 m/s², max. travel distance 10 m at 20°C.

Electrical/Network Characteristics:



The cable is tested according to the following standards: IEEE 802.3 : Ethernet 10Base-T; Fast Ethernet 100Base-T ; Gigabit Ethernet 1000Base-T @ 95-Meter



The cable is tested according to the following standards: IEEE 802.3at. PoE+, max. 30W per channel, max. 95m.



The cable is constructed with an additional power element:
 Square: 3 x 1.5 mm², Color code: BK-BU-GN/YE.

The Connection Rail Series - Plug & Play Compact Cabinets for Safe Areas



Connection Rail - Series

The **ConnectionRail Series** converts video, audio and binary signals in ethernet-network streams, making them available over long distances. Interface diversity makes our ConnectionRails solve every digitalization task. Network connection can be realized via optical fibers, copper-bound Ethernet or WLAN..

Connection Rail
with stainless steel housing

Group II (Gas & Dust)	-				
Zone	0	1	2	21	22
Application	✗	✗	✗	✗	✗

Group I (Mining)	-	
Category	Ma	Mb
Application	✗	✗

Product / Model	Description
Connection Rail T05-4PoE+-100BaseTX 	High performance PoE-Switch for the safe area Compact cabinet, for wall mounting Protection level: IP 66 (IEC / EN 60529) Ambient temperature: $-10^{\circ}\text{C} < T_{\text{amb}} < +50^{\circ}\text{C}$ Material: Stainless steel 1.4301 Dimension: 300 x 300 x 210 mm Input power: 100 VAC - 240 VAC Network input: 4 x PoE+ (10/100BaseT(X), IEEE 802.3at, max. 30W per port) Network uplink: 1 x 100BaseTX Cable glands: 5 x cable gland M20x1.5 (camera & uplink) 1 x cable gland M25x1.5 (power supply & FOC) Product group: B, tariff number: 8517 6200
Connection Rail T05-8PoE+-1000BaseTX 	High performance PoE-Switch for the safe area Compact cabinet, for wall mounting Protection level: IP 66 (IEC / EN 60529) Ambient temperature: $-10^{\circ}\text{C} < T_{\text{amb}} < +50^{\circ}\text{C}$ Material: Stainless steel 1.4301 Dimension: 300 x 300 x 210 mm Input power: 100 VAC - 240VAC Network input: 8 x PoE+ (10/100BaseT(X), IEEE 802.3at, max. 30W per port) Network uplink: 1 x 10/100/1000BaseTX Cable glands: 8 x cable gland M20x1.5 (camera) 2 x cable gland M25x1.5 (power supply & Ethernet Uplink) Product group: B, tariff number: 8517 6200
Further Options	Many further Options through combination with different accessories are possible; they can be found in chapter accessories for (Ex-) Connection Rails & Racks If you have a specific problem please ask us.
Connection Rack	Integration solution for 19 inch cabinets

The ExConnection Rail Series - Connection and Transmission Units for Ex- Zones













ExConnection Rail - PoE
in an Ex-de Enclosure

ExConnection Rail - PoE

High performance PoE switches for hazardous areas. The ExConnection Rail - PoE is designed to connect our **digital PoE cameras**. The ExConnection Rail - PoE's centerpieces are high performance GigE network switches. As an option, the **FX ports can also be executed to reflect the ignition protection category [op is]**. The ExConnection Rail - PoE allows the connection of up to 16 PoE cameras. The connection of the GBit/s FX ports is possible over very large distances.

Group II (Gas & Dust)	ATEX				
Zone	0	1	2	21	22
Application	✗	✓	✓	✓	✓

Group I (Mining)	ATEX	
Category	Ma	Mb
Application	✗	✗

Product / Model	Description	
ExConnection Rail 4P T04.4-D-4PoE+-100BaseTX 	   	High performance PoE-Switch for hazardous areas. Explosion proof (Ex-d) housing for wall mounting. Explosion protection certification according to 2014/34/EU (ATEX) & IECEx Explosion protection (gas): Ex II 2G Ex d IIC T6 Gb Explosion protection (dust): Ex II 2D Ex tb IIIC T80°C Db Protection level: IP 66 (IEC / EN 60529) Ambient temperature: $-10^{\circ}\text{C} < T_{\text{amb}} < +50^{\circ}\text{C}$ Material: aluminum, copper-free & seawater-resistant Dimensions: 236 x 236 x 227 mm Input power: 100 VAC - 240 VAC Network input: 4 x PoE+ (10/100BaseT(X), IEEE 802.3at, max. 30W per port) Network uplink: 1 x 100BaseTX Provided cable glands: 5 x Cable gland M20x1.5 (rubber sealed) (cameras & uplink) 1 x Cable gland M25x1.5 (rubber sealed) (power supply) Please observe standard EN 60079-14! Product group: B, tariff number: 8517 6200
ExConnection Rail 8P T04.5-D-8PoE + -1000BaseTX 	   	High-performance PoE switch for hazardous areas Flameproof enclosure for wall mounting Explosion protection approval according to Directive 2014/34 / EU (ATEX) & IECEx Explosion protection (gas): Ex II 2G Ex d IIC T6 Gb Explosion protection (dust): Ex II 2D Ex tb IIIC T80 ° C Db Protection class: IP 66 (IEC / EN 60529) Ambient temperature: $-10^{\circ}\text{C} < T_{\text{amb}} < +50^{\circ}\text{C}$ Material: lacquered aluminum RAL 7032, copper-free & seawater-resistant Dimension: 285 x 285 x 230 mm Input voltage: 100 VAC - 240 VAC Network input: 8 x PoE + (10 / 100BaseT (X), IEEE 802.3at, max 30W per port) Network Uplink: 1 x 10/100/1000BaseTX (copper) Enclosed cable entries: 8 x Gland M20x1,5 (rubber seal) (cameras) 2 x Gland M25x1.5 (barriere gland) (power & uplink) Please refer to EN 60079-14! Product group: B, tariff number: 8517 6200
Options		Through combination of different accessories many further variants are available; see chapter Accessories for (Ex-) Connection Rails & Racks.

Accessories for (Ex)Connection Rail Series



Accessories

By combining different accessories the **(Ex)Connection Rail & Rack** Series offers much more possibilities and variants. Interface diversity makes our Connection Rails solve every digitalization task. Cameras from renowned manufacturers can be controlled via RS422 or RS485 interface network-based. Network integrations can be realized via optical fibres, copper bound Ethernet or WLAN. These transfer media can be varied as needed.

Connection Rail

exemplary presentation

Product / Model	Description
Power Supply 230V AC / 24V DC	Our (Ex-) Connection Rails as well as the connected camera-systems can require different power supplies. Existing systems are often provided with 24V AC, modern systems with 24V DC or 230V AC. This applies to both, Connection Rails and camera systems. We are able to realize all these voltage levels for you independent from the power requirements! Send us your request. Product group: B
„WLAN“	Optional accessory <u>WLAN</u> (surcharge): For use in explosive area please note: Deviations in the ex-marking are possible! Product group: B
„I/O“	Optional accessory <u>„I/O“</u> (surcharge): With the „I/O“ package, an easy but effective communication with external devices or systems can be set up. With the binary outputs, lights and safety gates, for example, can be switched on by motion detection. With the binary outputs, external commands, such as recordings, can be transferred to the video system. Product group: B
Ethernet ST Patchfeld	Ethernet ST Patchfeld LWL [op is] in an ex-e terminal box
„Plug“	Optional accessory (surcharge): Ex-plug. All connections are pluggable. Different systems available Product group: B
„mobile“	Optional accessory (surcharge): „mobile“ The system is mounted at a portable stainless steel frame. Product group: B
Lid with Sight Glass	Optional accessory (surcharge): Sight glass Model with sight glass for simple visual check of the status LEDs Product group: B
Coating	Protective Coating / Powder coating (surcharge): Maximum corrosion resistance, additional protection under increased mechanical loading, special RAL color desired Product group: B
Housing Heating for arctic temperatures	Optional accessory heating (surcharge): Equipped with a self-regulating heater to meet extremely low temperature ranges (up to -60°C). Product group: B
BTO	Build-to-Order-Variants ...

Our Customers

		more customers at WWW.SAMCON.EU		

Our Team



Our Certificates



more certificates at WWW.SAMCON.EU

Our Type Examinations



EG-Baumusterprüfbescheinigung
- Richtlinie 94/9/EG -
Geräte und Schutzsysteme zur bestimmungsgemäßen Verwendung in explosionsgefährdeten Bereichen

BVS 08 ATEX E 073 X

Geräte: Kamerastellen Typ ExCan360[®]
Hersteller: Samcon Prozessleittechnik GmbH
Anschriß: 35102 Lohra-Altenvers
Die Bauart dieses Gerätes sowie die verschiedenen zulässigen Ausführungen sind in der Anlage zu dieser Baumusterprüfbescheinigung festgelegt.
Die TÜV Rheinland - Zertifizierungsstelle für Ex-Baumuster-Produkte der TÜV Rheinland Industrie Service GmbH, bescheinigt als benannte Stelle Nr. 0205 nach Artikel 9 der Richtlinie 94/9/EG die Erfüllung der grundlegenden Sicherheits- und Gesundheitsanforderungen für die Konzeption und den Bau von Geräten und Schutzsystemen zur bestimmungsgemäßen Verwendung in explosionsgefährdeten Bereichen gemäß Anlage I der Richtlinie 94/9/EG.
Die Ergebnisse der Prüfung sind in dem Prüfprotokoll BVS PP 03.2011 EG niedergelegt.
Die grundlegenden Sicherheits- und Gesundheitsanforderungen werden erfüllt durch Überwindung mit:
EN 60079-0:2006 Allgemeine Anforderungen
EN 60079-1:2004 Drucklose Kapazität "C"
EN 60079-2:2002 Extragelände und Übertragungsgeräte die mit optischer Strahlung arbeiten.
Falls das Zeichen "X" hinter der Bescheinigungsnummer steht, wird in der Anlage zu dieser Bescheinigung auf besondere Bedingungen für die sichere Anwendung des Gerätes hingewiesen.
Diese EG-Baumusterprüfbescheinigung bezieht sich nur auf die Konzeption und den Bau der bescheinigten Geräte in Übereinstimmung mit der Richtlinie 94/9/EG. Für Herstellung und in weiterer Folge des Gerätes sind weitere Anforderungen der Richtlinie zu erfüllen, die nicht durch diese Bescheinigung abgedeckt sind.
Die Kennzeichnung des Gerätes muss die folgenden Angaben enthalten:
II 2G Ex de [op n] IIB T5

DEKRA EXAM GmbH
Bochum, den 21. Juni 2008



DEKRA EXAM GmbH
Bochum, den 21. Juni 2008



EG-Baumusterprüfbescheinigung
- Richtlinie 94/9/EG -
Geräte und Schutzsysteme zur bestimmungsgemäßen Verwendung in explosionsgefährdeten Bereichen

BVS 07 ATEX I 183 U

Komponente: DECT Interface Typ ExNF
Hersteller: Samcon Prozessleittechnik GmbH
Anschriß: 35102 Lohra-Altenvers
Die Bauart dieser Komponente sowie die verschiedenen zulässigen Ausführungen sind in der Anlage zu dieser Baumusterprüfbescheinigung festgelegt.
Die Zertifizierungsstelle der DEKRA EXAM GmbH, benannte Stelle Nr. 0208 gemäß Artikel 9 der Richtlinie 94/9/EG des Europäischen Parlaments und des Rates vom 23. März 1994, bescheinigt, dass die Komponente den grundlegenden Sicherheits- und Gesundheitsanforderungen für die Konzeption und den Bau von Geräten und Schutzsystemen zur bestimmungsgemäßen Verwendung in explosionsgefährdeten Bereichen gemäß Anlage I der Richtlinie 94/9/EG.
Die Ergebnisse der Prüfung sind in dem Prüfprotokoll BVS PP 07.2178 EG niedergelegt.
Die grundlegenden Sicherheits- und Gesundheitsanforderungen werden erfüllt durch Überwindung mit:
IEC 60079-0:2007 Allgemeine Anforderungen
Das Zeichen "U" hinter der Bescheinigungsnummer gibt an, dass dieses Zertifikat nicht mit einem für ein Gerät oder Schutzsystem vorgesehenen Zertifikat verwechselt werden darf. Dieses Zertifikat darf nur als Basis für die Bescheinigung eines Gerätes oder Schutzsystems verwendet werden.
Diese EG-Baumusterprüfbescheinigung bezieht sich nur auf die Konzeption und die Baumusterprüfung der bescheinigten Komponente in Übereinstimmung mit der Richtlinie 94/9/EG. Für Herstellung und Inbetriebnahme der Komponente sind weitere Anforderungen der Richtlinie zu erfüllen, die nicht durch diese Bescheinigung abgedeckt sind.
Die Kennzeichnung der Komponente muss die folgenden Angaben enthalten:
II (2) G Ex IIB

DEKRA EXAM GmbH
Bochum, den 21. März 2008

Zertifizierungsstelle Fachbereich

EG-Baumusterprüfbescheinigung

Geräte und Schutzsysteme zur bestimmungsgemäßen Verwendung in explosionsgefährdeten Bereichen - Richtlinie 94/9/EG

EG-Baumusterprüfbescheinigungsnummer

TÜV 09 ATEX 7697 X

Geräte: ExCam miniZoom Typ T55-VA... und Typ T50...
Hersteller: SAMCON Prozessleittechnik GmbH
Anschriß: Schillerstraße 17, 35102 Lohra-Altenvers
Die Bauart dieses Gerätes sowie die verschiedenen zulässigen Ausführungen sind in der Anlage zu dieser Baumusterprüfbescheinigung festgelegt.
Die TÜV CERT - Zertifizierungsstelle für Ex-Baumuster-Produkte der TÜV Rheinland Industrie Service GmbH, TÜV Rheinland GmbH, bescheinigt als benannte Stelle Nr. 0205 nach Artikel 9 der Richtlinie des Rates der Europäischen Gemeinschaften vom 23. März 1994 (94/9/EG) die Erfüllung der grundlegenden Sicherheits- und Gesundheitsanforderungen für die Konzeption und den Bau von Geräten und Schutzsystemen zur bestimmungsgemäßen Verwendung in explosionsgefährdeten Bereichen gemäß Anlage I der Richtlinie.
Die Ergebnisse der Prüfung sind in dem verfahrens Protokoll Nr. 19434007/0003 festgelegt.
Die grundlegenden Sicherheits- und Gesundheitsanforderungen werden erfüllt durch Überwindung mit:
EN 60079-0:2006, EN 60079-1:2007, EN 61241-0:2006, EN 61241-1:2004
mit Ausnahme der Anforderungen, die in Punkt 18 der Anlage genannt sind.
Falls das Zeichen "X" hinter der Bescheinigungsnummer steht, wird auf besondere Bedingungen für die sichere Anwendung des Gerätes in der Anlage zu dieser Bescheinigung hingewiesen.
Diese EG-Baumusterprüfbescheinigung bezieht sich nur auf die Konzeption und den Bau der bescheinigten Geräte gemäß Richtlinie 94/9/EG. Weitere Anforderungen dieser Richtlinie gelten für die Herstellung und die Inbetriebnahme dieses Gerätes. Diese Anforderungen werden durch diese Bescheinigung nicht abgedeckt.
Die Kennzeichnung des Gerätes muss die folgenden Angaben enthalten:
II 2 G Ex de IIC T6 oder Ex de IIB T6

TÜV CERT - Zertifizierungsstelle für Ex-Baumuster-Produkte Köln, den 23.04.2009



TÜV CERT - Zertifizierungsstelle für Ex-Baumuster-Produkte Köln, den 23.04.2009

www.tuv.com

TÜVRheinland
Genoss. Richtig.

EG-Baumusterprüfbescheinigung

Geräte und Schutzsysteme zur bestimmungsgemäßen Verwendung in explosionsgefährdeten Bereichen - Richtlinie 94/9/EG

EG-Baumusterprüfbescheinigungsnummer

TÜV 10 ATEX 7969 X

Geräte: ExConnection Rail Typ T04
Hersteller: SAMCON Prozessleittechnik GmbH
Anschriß: Schillerstraße 17, 35102 Lohra-Altenvers
Die Bauart dieses Gerätes sowie die verschiedenen zulässigen Ausführungen sind in der Anlage zu dieser Baumusterprüfbescheinigung festgelegt.
Die TÜV Rheinland - Zertifizierungsstelle für Ex-Baumuster-Produkte der TÜV Rheinland Industrie Service GmbH, bescheinigt als benannte Stelle Nr. 0205 nach Artikel 9 der Richtlinie des Rates der Europäischen Gemeinschaften vom 23. März 1994 (94/9/EG) die Erfüllung der grundlegenden Sicherheits- und Gesundheitsanforderungen für die Konzeption und den Bau von Geräten und Schutzsystemen zur bestimmungsgemäßen Verwendung in explosionsgefährdeten Bereichen gemäß Anlage I der Richtlinie.
Die Ergebnisse der Prüfung sind in dem verfahrens Protokoll Nr. 037E4989 0010 festgelegt.
Die grundlegenden Sicherheits- und Gesundheitsanforderungen werden erfüllt durch Überwindung mit:
EN 60079-0:2006 EN 60079-1:2007 EN 60079-2:2007 EN 60079-3:2007
EN 60079-26:2007 EN 61241-0:2006 EN 61241-1:2004
mit Ausnahme der Anforderungen, die in Punkt 18 der Anlage genannt sind.
Falls das Zeichen "X" hinter der Bescheinigungsnummer steht, wird auf besondere Bedingungen für die sichere Anwendung des Gerätes in der Anlage zu dieser Bescheinigung hingewiesen.
Diese EG-Baumusterprüfbescheinigung bezieht sich nur auf die Konzeption und den Bau der bescheinigten Geräte gemäß Richtlinie 94/9/EG. Weitere Anforderungen dieser Richtlinie gelten für die Herstellung und die Inbetriebnahme dieses Gerätes. Diese Anforderungen werden durch diese Bescheinigung nicht abgedeckt.
Die Kennzeichnung des Gerätes muss die folgenden Angaben enthalten:
II 2 G Ex de e mb [a] n [op n] IIC T6 Varianten siehe Beschreibung
II 2 G Ex de IIC T6 Varianten siehe Beschreibung

TÜV Rheinland - Zertifizierungsstelle für Explosionschutz Köln, 10. Dezember 2011



TÜVRheinland
Genoss. Richtig.

MASC Mining And Surface Certification (Phy) Ltd

fsanas

Issue Date: 10 December 2018
Expiry Date: 10 December 2021
IA Certificate Number: MASC M/18-2558X
Date: 18-2558

IA - CERTIFICATE

ExCam Series T08

This document is based on and must be read in conjunction with the certificate IECEx TUR 18 0233X.

Further to your request, we have evaluated the supplied documentation.

The following is specified:

Description	Detail
Requested By	SAMCON Prozessleittechnik GmbH Schillerstraße 17 D-35102 Lohra-Altenvers Germany
Equipment	ExCam Series T08
Manufacturer	SAMCON Prozessleittechnik GmbH Schillerstraße 17 D-35102 Lohra-Altenvers Germany
Model(s) / Type(s)	ExCam Series T08
Rating	Ex de IIC T6 Gb Ex de IIC T6 Gb "See Marking below"
Certification body	TÜV Rheinland Industrie Service GmbH
Type Certificate No.	IECEx TUR 18 0233X
Variation/Issue/Amendment:	0
Assessment Report No.	DETR/ATR/18 023300
Quality Assurance Report (QAR) / Notification (Q/N)	DETR/VCAR/18 020504

Mining and Surface Certification (Phy) Ltd Reg No: 201560294607
Unit 6, Lane 7A, Ex-Argus Area, Herringfleet Industrial Estate, Herringfleet, Suffolk, IP20 9JL, UK
Tel: +44 (0)1473 832222 Fax: +44 (0)1473 832223
Email: info@fsanas.com

I. STANDARDS

EU-TYPE EXAMINATION CERTIFICATE

Equipment and Protective Systems Covered for use in
Zone IIa of Potentially Explosive Atmospheres - Directive 2014/54/EU

EU-Type Examination Certificate Number

TÜV 18 ATEX 8218 X Köln 07

Equipment: ExCam Series T08
Manufacturer: SAMCON Prozessleittechnik GmbH
Schillerstraße 17, 35102 Lohra-Altenvers
The manufacturer's technical file shall be available for inspection at the address specified in the certificate and shall contain the following information:
The "EU-EXAMINATION CERTIFICATE" procedure is based on the technical file of the manufacturer. The certificate is issued on the basis of the technical file of the manufacturer. The certificate is issued on the basis of the technical file of the manufacturer. The certificate is issued on the basis of the technical file of the manufacturer.
The examination and test results are recorded in the confidential report 557E/VS/18 023300.
Compliance with the Essential Health and Safety Requirements, with the exception of those listed in the schedule of this certificate, has been assessed by reference to:
EN 60079-0:2014 EN 60079-1:2014 EN 60079-2:2014 EN 60079-3:2014
EN 60079-26:2016 EN 60079-26:2016 EN 60079-26:2016 EN 60079-26:2016
The marking of the equipment shall include the following:
II 2G Ex de IIC T6 Gb **II 2G Ex de IIB T6**
II 2G Ex de IIC T6 Gb IP68 **II 2G Ex de IIB T6**

TÜV Rheinland - Zertifizierungsstelle für Explosionschutz Köln, 2018-12-10



TÜVRheinland
Genoss. Richtig.

IECEx Certificate of Conformity

INTERNATIONAL ELECTROTECHNICAL COMMISSION
IEC Certification Scheme for Explosive Atmospheres

Certificate No.: IECEx TUR 18 0233X Issue No: 0 Certificate history Issue No: 1 (2018-12-10)

Status: Current Page 1 of 3

Date of Issue: 2018-07-28

Applicant: SAMCON Prozessleittechnik GmbH
Schillerstraße 17
D-35102 Lohra-Altenvers
Germany

Electrical Apparatus: Ex safety enclosure series T04 MA 1 V/A 2

Electrical category: Ex de IIC T6
Type of Protection: Ex de IIC T6
Marking: Ex de IIC T6
Ex de IIC T6 Gb
Ex de IIC T6 Gb IP68

Approval for issue on behalf of the IECEx: Dipl.-Ing. Klausener Druff
Certification Body: Head of Certification Body

1. This certificate and schedule may only be reproduced in full.
2. This certificate is not transferable and remains the property of the issuing body.
3. The status and authenticity of this certificate may be verified by using the IECEx website.

Certificate issued by: TÜV Rheinland Industrie Service GmbH
An der Stein 28
51109 Cologne
Germany



TÜVRheinland
Genoss. Richtig.

IEC TYPE-EXAMINATION CERTIFICATE

Equipment and Protective Systems Intended for use in
Potentially Explosive Atmospheres - Directive 2014/54/EU

IEC Type-Examination Certificate Number

TÜV 14 ATEX 7539 X

Equipment: ExCam Series T08
Manufacturer: SAMCON Prozessleittechnik GmbH
Schillerstraße 17, 35102 Lohra-Altenvers
The equipment and any acceptable variation thereto are specified in the schedule to this certificate and the schedule is referred to.
The TÜV Rheinland - Zertifizierungsstelle für Ex-Baumuster-Produkte der TÜV Rheinland Industrie Service GmbH, benannte Stelle Nr. 0205 in accordance with Article 9 of the Council Directive 94/9/EC of 23 March 1994, certifies that the equipment has been found to comply with the Essential Health and Safety Requirements relating to the design and construction of equipment and protective systems intended for use in potentially explosive atmospheres, given in Annex I to the Directive.
The examination and test results are recorded in the confidential report 557E/VS/18 023300.
Compliance with the Essential Health and Safety Requirements, with the exception of those listed in the schedule of this certificate, has been assessed by reference to:
EN 60079-0:2012 EN 60079-1:2007 EN 60079-2:2007 EN 60079-3:2007
EN 60079-26:2016 EN 60079-26:2016 EN 60079-26:2016 EN 60079-26:2016
If the sign "X" is placed after the certificate number, it indicates that the equipment is subject to special conditions for safe use specified in the schedule to this certificate.
This IEC-Type Examination Certificate relates only to the design and specification for construction of the equipment or protective system. It does not cover the procedure for actual manufacture or supply of the equipment or protective system, for which further requirements of the directive are applicable.
The marking of the equipment shall include the following:
II 2G Ex de IIB
II 2G Ex de IIC T6 Gb or **Ex de IIC T6 Gb**
II 2G Ex de IIC T6 Gb or **Ex de IIC T6 Gb**
II 2G Ex de IIC T6 Gb IP68 or **II 2G Ex de IIC T6 Gb IP68**

TÜV Rheinland ExLab für explosionsgefährdete Umgebung Cologne, 2014-07-29



TÜVRheinland
Genoss. Richtig.

IECEx Certificate of Conformity

INTERNATIONAL ELECTROTECHNICAL COMMISSION
IEC Certification Scheme for Explosive Atmospheres

Certificate No.: IECEx TUR 18 0233X Issue No: 0 Certificate history Issue No: 1 (2018-12-10)

Status: Current Page 1 of 3

Date of Issue: 2018-07-28

Applicant: SAMCON Prozessleittechnik GmbH
Schillerstraße 17
D-35102 Lohra-Altenvers
Germany

Electrical Apparatus: ExCam Series T08

Electrical category: Ex de IIC T6
Type of Protection: Ex de IIC T6
Marking: Ex de IIC T6
Ex de IIC T6 Gb
Ex de IIC T6 Gb IP68
Ex de IIC T6 Gb, Ex de IIC T6 Gb
Ex de IIC T6 Gb, Ex de IIC T6 Gb

Approval for issue on behalf of the IECEx: Hans Fuchs
Certification Body: Head of Certification Body

1. This certificate and schedule may only be reproduced in full.
2. This certificate is not transferable and remains the property of the issuing body.
3. The status and authenticity of this certificate may be verified by using the IECEx website.

Certificate issued by: TÜV Rheinland Industrie Service GmbH
An der Stein 28
51109 Cologne
Germany



TÜVRheinland
Genoss. Richtig.

ExCam Series Model Key

ExCam Series - Product - Model- Overview

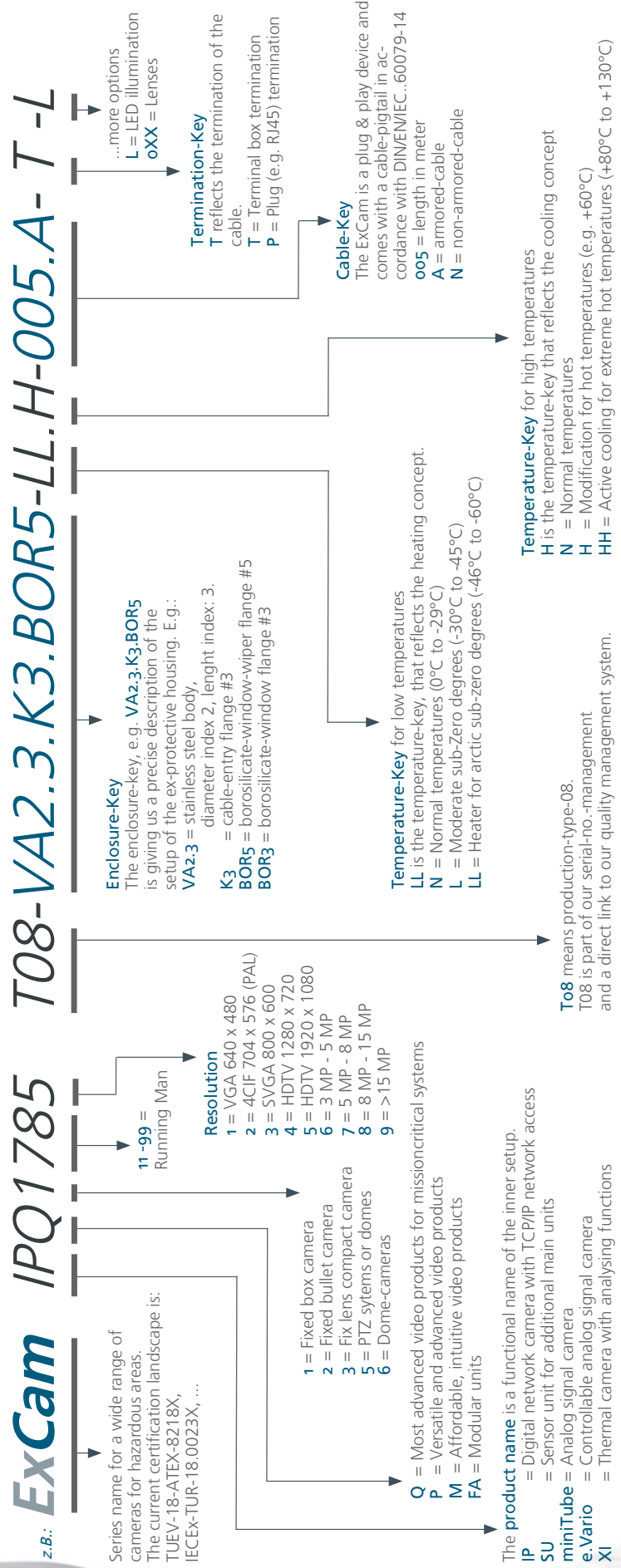
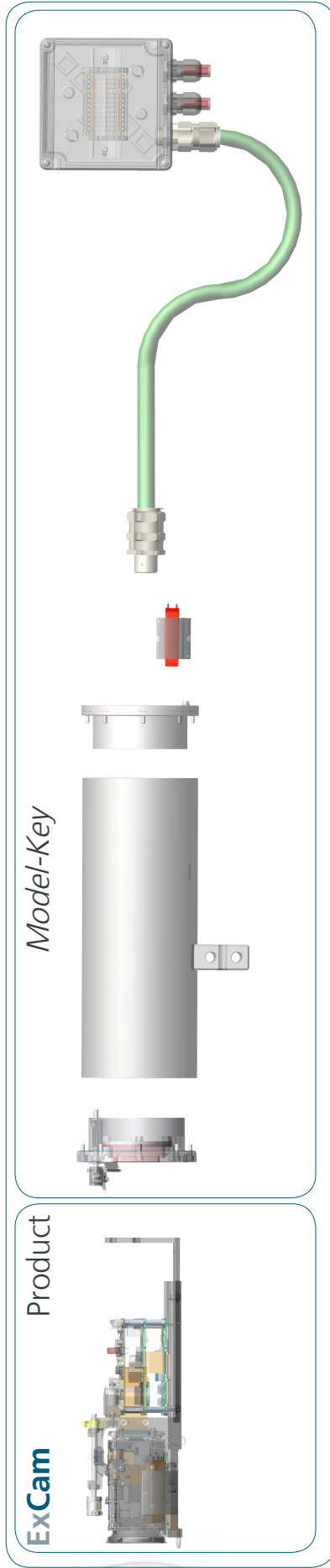



MZ Construction Consumable Supply LTD
10 North Avenue, Hayes,
Middlesex, United Kingdom,
UB3 2JE
Contact Number:
+442080610941
+447424438725

Contact Email: mz@mzccs.co.uk
Web site: www.mzccs.co.uk



Rev. Date/Author: 26.09.2024/ES



Schillerstrasse 17, D-35102 Lohra-Altenvers
www.samcon.eu, info@samcon.eu
fon: +49 6426 9231-0, fax: -31